

info@asa-intl.com

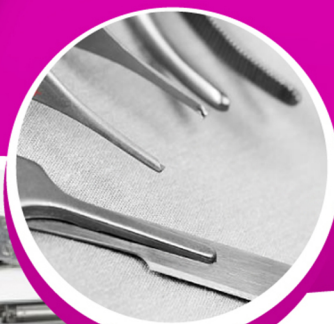

ASA

The name of Excellence

Manufacturer & Exporter All Kinds of

SURGICAL INSTRUMENTS



MHRA
Regulating Medicines and Medical Devices

Percussion Hammers and Aesthesiometers



AS-01-101
TROEMNER
Size: 245 mm

1/2



AS-01-102
DEJERINE
Size: 200 mm

1/2



AS-01-103
DEJERINE
with needle
Size: 210 mm

1/2



AS-01-104
TAYLOR
Size: 195 mm

1/2



AS-01-105
BERLINER
Size: 200 mm

1/2



AS-01-106
BUCK
with needle
and brush
Size: 180 mm

1/2



AS-01-107
RABINER
with needle
and brush
Size: 255 mm

1/2



AS-01-108
ALY
Size: 190 mm

1/2

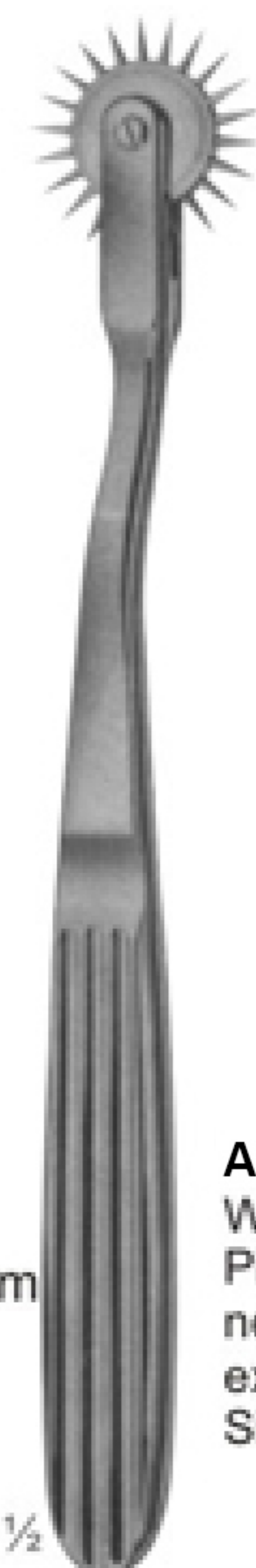

AS-01-109
WARTENBERG
Pinwheel for
neurological
examination
Size: 185 mm

1/2

Stethoscopes



AS-01-110
PINARD (Aluminum)
Size: 155 mm

1/2



AS-01-111
wooden
Size: 145 mm

1/2



AS-01-112
BOWLES
Stethoscope
with diaphragm

1/4



AS-01-113
ANESTOPHON

1/2



AS-01-114
FORD-BOWLES
Dual chest piece
with two outlets

1/4



AS-01-115
BOWLES

1/4

Head Mirrors and Head Bands

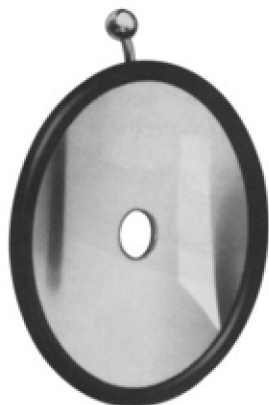

AS-01-116
ZIEGLER \varnothing 90mm
head mirror only
with rubber coating

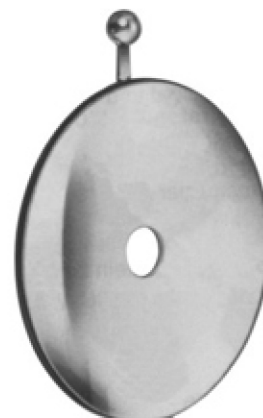

AS-01-117
ZIEGLER \varnothing 90mm
head mirror only
with metal coating



AS-01-118
ZIEGLER
head band of plastic black

AS-01-119
ZIEGLER
head band of plastic white

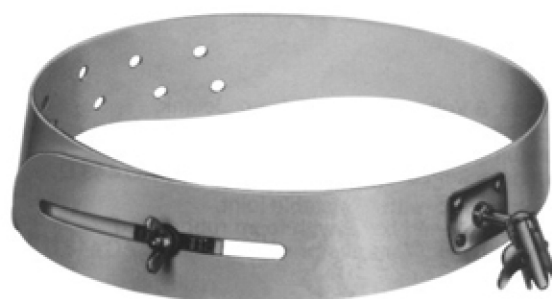

AS-01-120
MURPHY
head band of celluloid, white

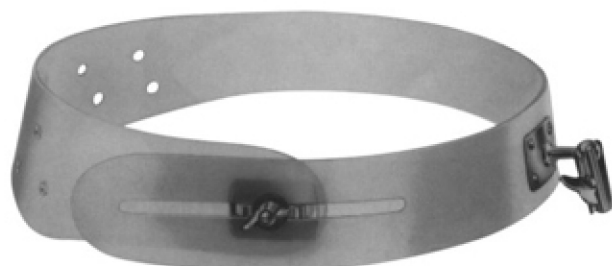

AS-01-121
head band of plastic,
white, soft pattern



AS-01-122
head mirror with black
plastic head band.

Tongue Depressors

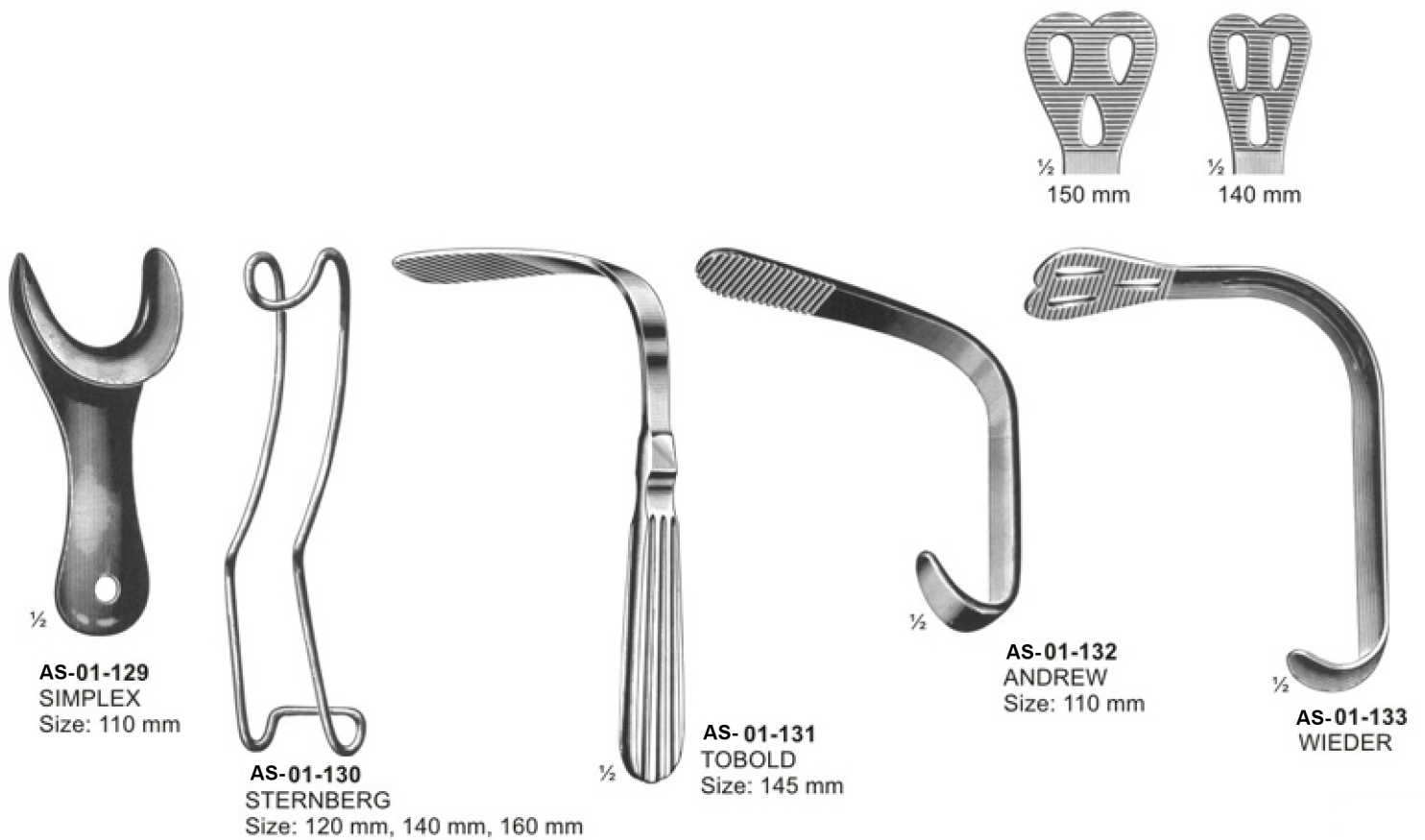
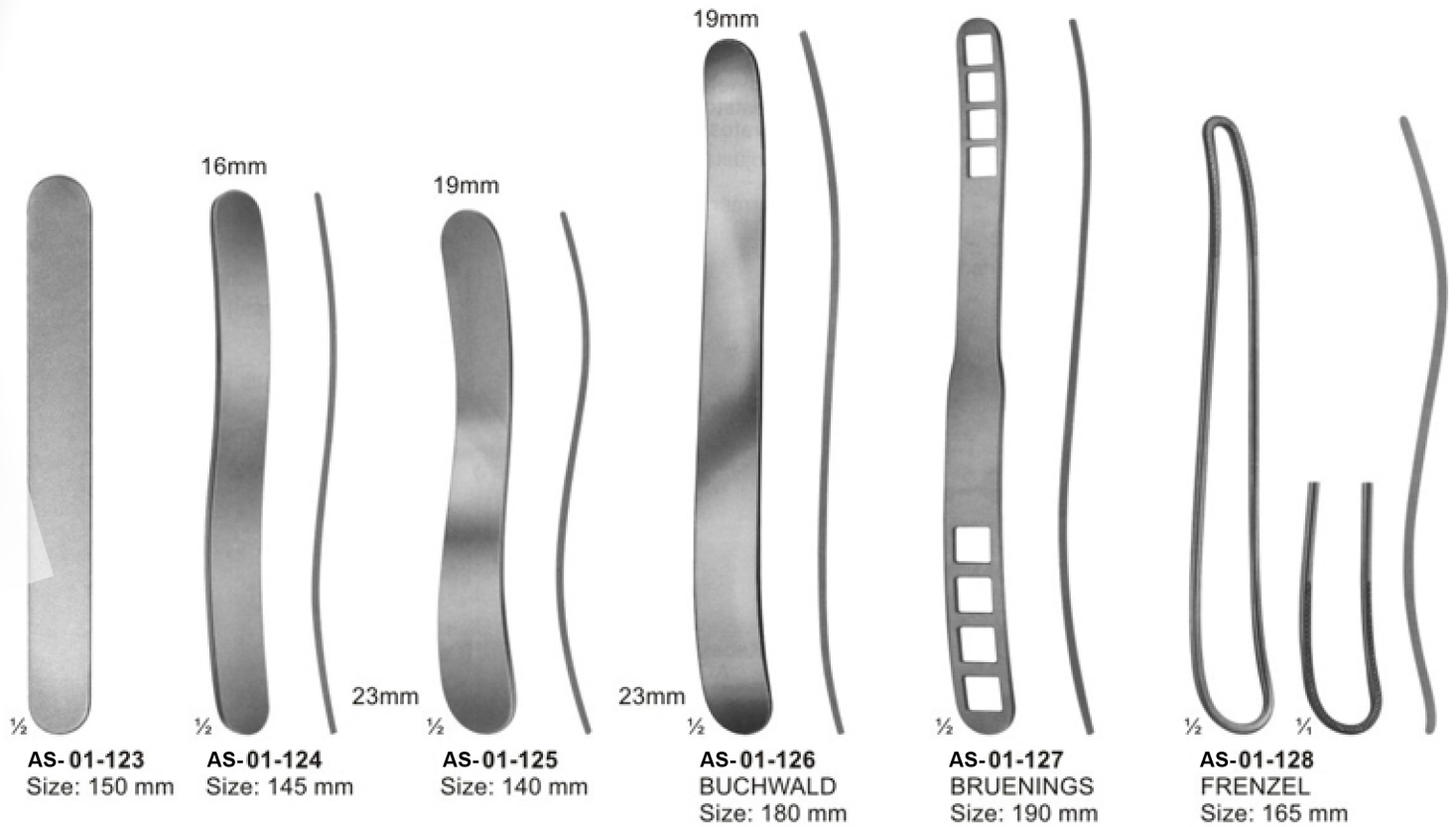

Instruments for Anaesthesia and Tongue Forceps



1/2

AS-01-134
SCHIMMELBUSCH
Ether mask



1/2

AS-01-135
HEISTER
Mouth gag
Size: 130 mm



1/2

AS-01-136
FERGUSON-ACKLAND
Mouth gag
Size: 145 mm



1/2

AS-01-137
DENHARDT
Mouth gag with silicon
inserts, interchangeable
Size: 125 mm



1/2

AS-01-138
ROSER KOENIG
Mouth gag
Size: 160 mm, 185 mm



1/2

AS-01-139
YOUNG
Size: 165 mm

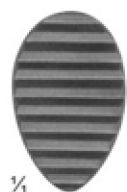

1/4

1 Pair Of
Rubber Pads

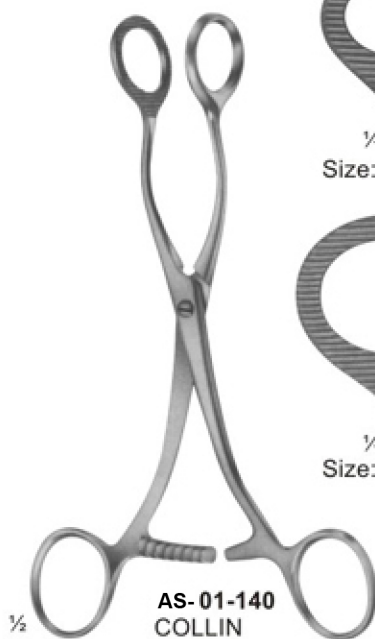

1/2

AS-01-140
COLLIN
Size: 160 mm,
170 mm



1/4

Size: 160 mm



1/4

Size: 170 mm

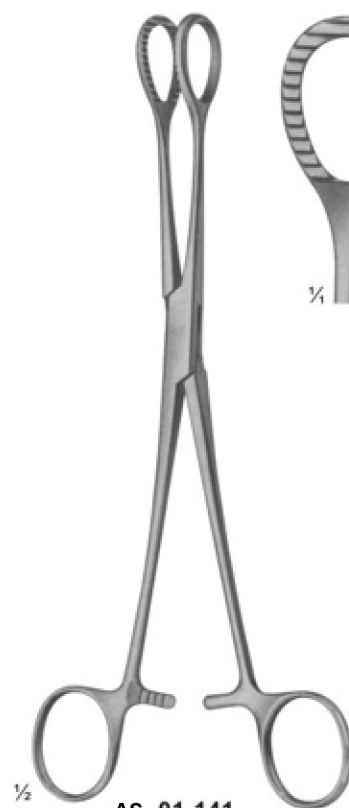

1/2

AS-01-141
HEYWOOD-SMITH
modif. Size: 215 mm



1/4

Blood Lancets and Laryngeal Mirrors

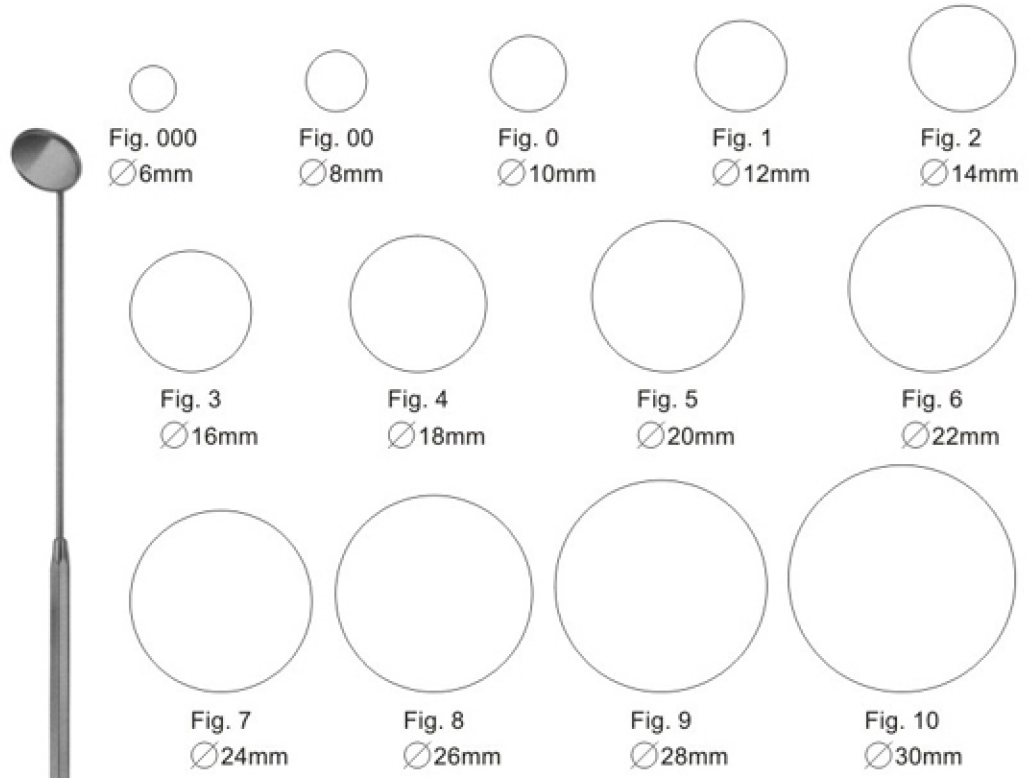

AS-01-142
FRANCKE
Automatic blood lancet



AS-01-143
Laryngeal mirrors with
hexagonal handle
Size: 180 mm

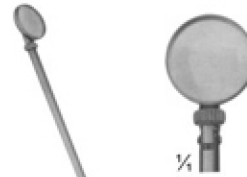

AS-01-148
Spare mirrors only
Size: 12 mm



AS-01-149
Spare mirrors only
Size: 14 mm



AS-01-144
KOLLE
Microscopic Needle
Holder with plastic
handle.
Size: 240 mm



AS-01-145
Mirror handle
Size: 110 mm



AS-01-146
Mirror handle
Size: 105 mm

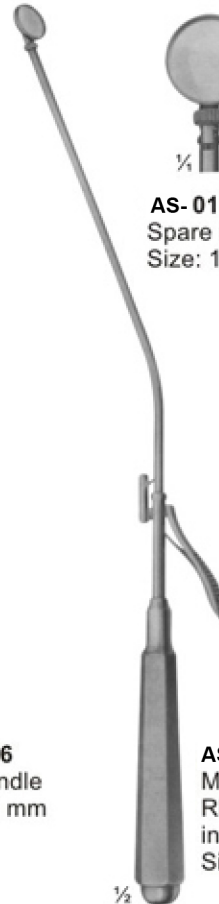

AS-01-147
MICHEL
Rhinoscopic mirrors with
interchangeable mirror inserts
Size: 250 mm

Laryngoscope and Diagnostic Sets



AS-01-150
Infants
Size: 150 mm



AS-01-151
Children
Size: 200 mm



AS-01-152
Adults
Size: 250 mm



AS-01-154



AS-01-150 - 152
MAGILL



AS-01-153
Medium battery handle
only, 25 mm diam.



AS-01-153-A
Spare bulb
2.7 volt, for
otoscopes



AS-01-153-B
Spare bulb
2.6 volt, for
ophthalmoscopes



AS-01-155



AS-01-156
Otoscope set, consists of
battery handle without batteries,
3 ear specula, 1 bulb in valvet lined case



AS-01-157
Diagnostic set, otoscope with three specula,
nasal speculam, lamp holder, two laryngeal
mirrors, tongue blade holder

Laryngoscopes



AS-01-158
MILLER
 Laryngoscope set, consists of battery handle (without battery)
 with four miller laryngoscope blades

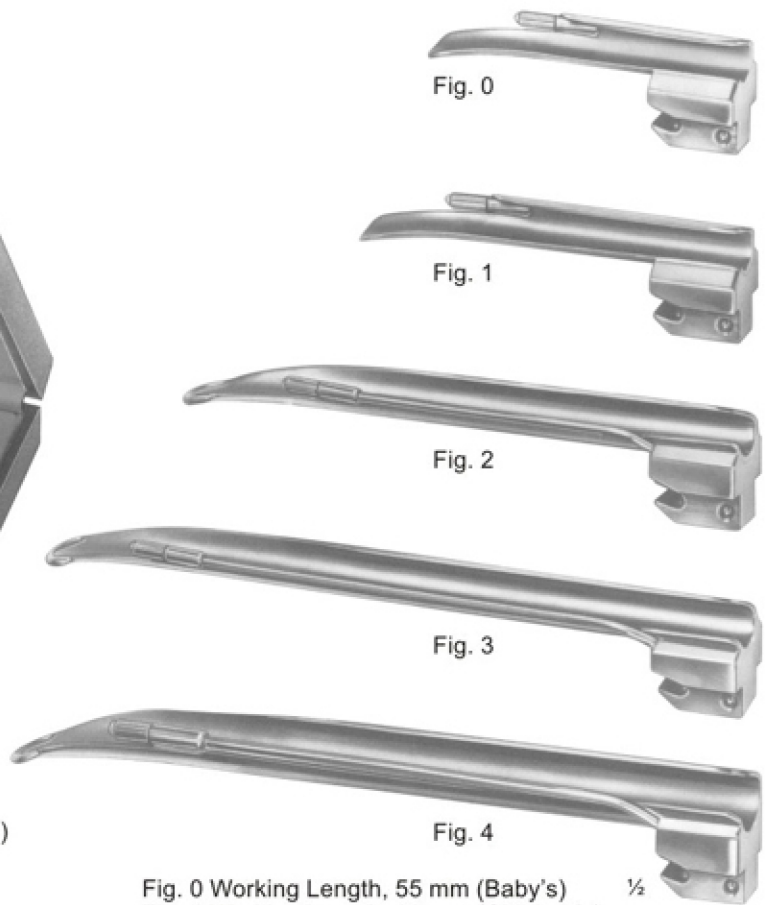

Fig. 0 Working Length, 55 mm (Baby's) $\frac{1}{2}$
 Fig. 1 Working Length, 80 mm (Children's)
 Fig. 2 Working Length, 130 mm (Adolescent's)
 Fig. 3 Working Length, 170 mm (Women's)
 Fig. 4 Working Length, 180 mm (Men's)



AS-01-159
GUEDEL-NEGUS
 Laryngoscope set, consists of battery handle (without battery)
 with four miller laryngoscope blades

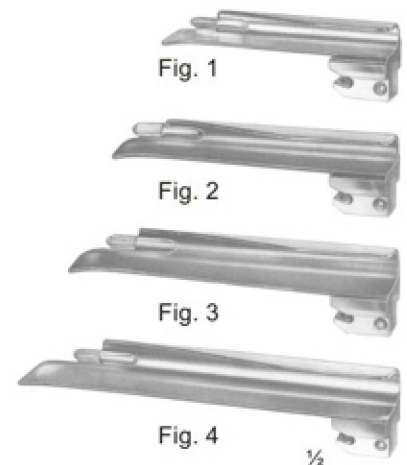

Fig. 1 Working Length, 70 mm (Children's)
 Fig. 2 Working Length, 90 mm (Adolescent's)
 Fig. 3 Working Length, 110 mm (Women's)
 Fig. 4 Working Length, 135 mm (Men's)

Laryngoscopes



AS-01-160
McINTOSH
Laryngoscope Set, Consists Of Battery Handle (Without Battery)
With Three McIntosh Blades, Fig. 1, Fig. 2, Fig. 3

AS-01-161
McINTOSH
Laryngoscope Set, Consists Of Battery Handle (Without Battery)
With Five McIntosh Blades, Fig. 0, Fig. 1, Fig. 2, Fig. 3, Fig. 4

Fig. 0

Fig. 1

Fig. 2

Fig. 3

Fig. 4

01-161 A Fig. 0 Working Length, 55 mm (Baby's)
01-161 B Fig. 1 Working Length, 75 mm (Children's)
01-161 C Fig. 2 Working Length, 90 mm (Adolescent's)
01-161 D Fig. 3 Working Length, 110 mm (Women's)
01-161 E Fig. 4 Working Length, 135 mm (Men's)

AS-01-162
FOREGGER
Laryngoscope Set, Consists Of
Battery Handle (Without Battery)
With Three Foregger Blades,
Fig. 1, Fig. 2, Fig. 3,



AS-01-163
FOREGGER
Laryngoscope Set, Consists Of
Battery Handle (Without Battery)
With Four Foregger Blades,
Fig. 1, Fig. 2, Fig. 3, Fig. 4,

Fig. 1

Fig. 2

Fig. 3

Fig. 4

01-162 A Fig. 1 Working Length, 70 mm (Children's)
01-162 B Fig. 2 Working Length, 90 mm (Adolescent's)
01-162 C Fig. 3 Working Length, 110 mm (Women's)
01-162 D Fig. 4 Working Length, 135 mm (Men's)



AS-01-164
Fiber Optic
Battery Handle
30mm diam.



AS-01-165
Fiber Optic
Battery Handle
18mm diam.



AS-01-166
Replacement Lamp
(Krypton) 2.5 V



AS-01-167
Replacement Lamp
(Halogen) 2.5 V

Examination & Measuring Instruments

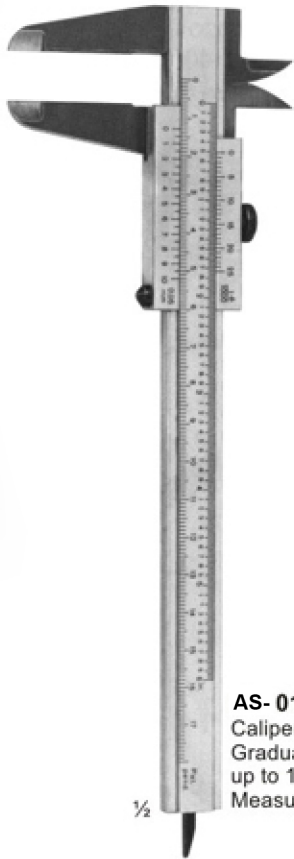

AS-01-168
Caliper Of Aluminium
Graduated in mm & inches
up to 180mm
Measuring Range up to 139mm



AS-01-169
VERNIER
Universal Caliper Of Steel
Graduated in mm & inches
up to 180mm
Measuring Range up to 120mm
with Vernier in 1/10mm & 1/16"



AS-01-170
CARROLL
Size: 145 mm
Finger Goniometer



AS-01-171
TOWNLEY
Graduated in
mm & inches
Size: 115 mm



AS-01-172
COLLIN
Druck Pressure 72 kg
Size: 125 mm



AS-01-173
BERTILLON
Caliper For Measuring The Head
Size: 320 mm



AS-01-174
CASTROVIEJO
Caliper
Size: 75mm



AS-01-175
MOLTGEN
Goniometer



AS-01-176
Size: 150 mm



AS-01-177
Size: 500 mm



The name of Excellence

ASA INTERNATIONAL

*Near Jamia Mosque Usman,
Kotli Behram Sialkot 51310 Pakistan
Mob / Whatsapp
+92 345 6749489 (Swift Response)
Phone Number
Tel :+92 52 4267150
Fax: +92 52 4267151
Email
info@asa-intl.net
Web
http://asa-intl.net*

ASA EXPORT HOUSE

*Sultan Soap Street,
Kotli Behram Sialkot 51310 Pakistan
Mob / Whatsapp
+92 345 6749489 (Swift Response)
Phone Number
Tel :+92 52 4262983
Fax: +92 52 4267151
Email
info@asa-intl.net
Web
http://asa-intl.net*



MHRA
Regulating Medicines and Medical Devices

