

info@asa-intl.com

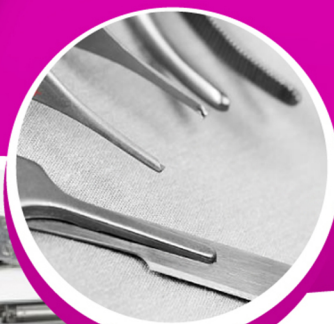

The name of Excellence

Manufacturer & Exporter All Kinds of

SURGICAL INSTRUMENTS



MHRA
Regulating Medicines and Medical Devices

Micro Scissors (Spring Type) with Flat Handles

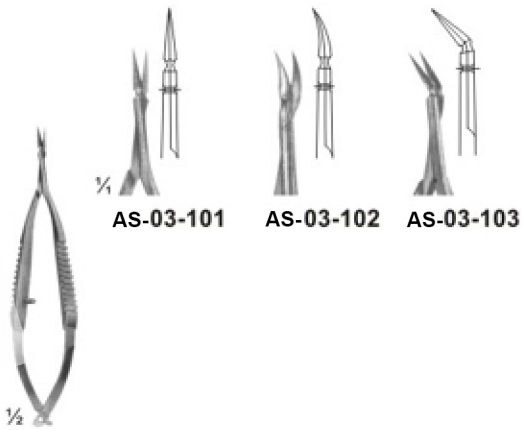

AS-03-101 - 103
VANNAS
Size: 85 mm



AS-03-104 - 105
CASTROVIEJO
Size: 95 mm

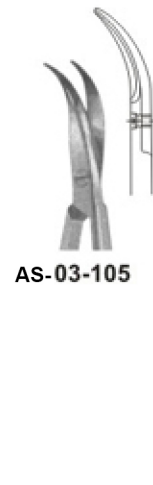

03-106
NOYES
Size: 125 mm

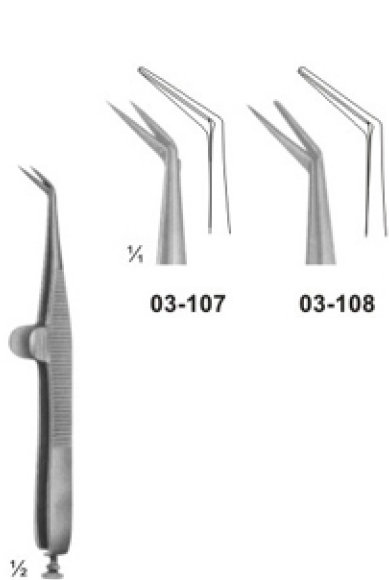

03-107 - 108
WECKER
Eye scissor
Size: 110 mm

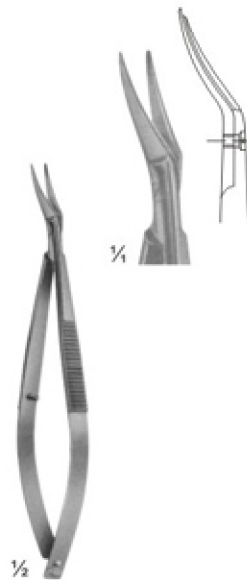

03-109
CASTROVIEJO
Eye scissor
Size: 115 mm

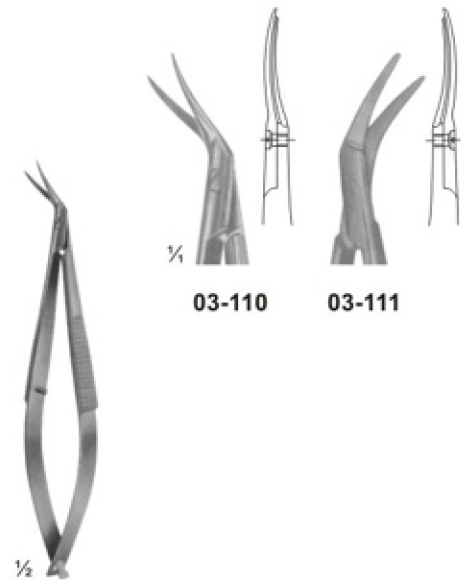

03-110 - 111
CASTROVIEJO
Eye scissor
Size: 110 mm

Micro Scissors (Spring Type) with Flat Handles



AS-03-112 AS-03-113

AS-03-112 - 113
Size: 120 mm

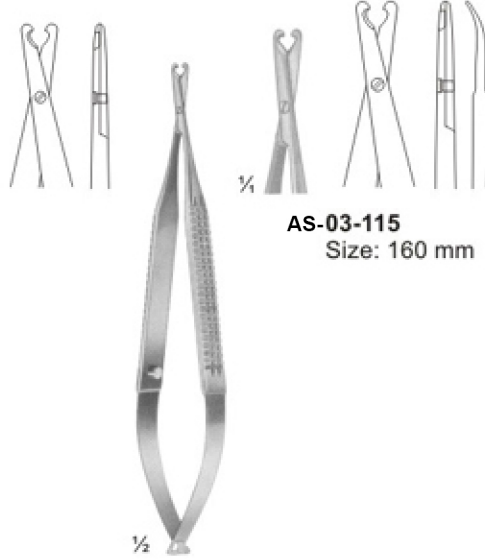

AS-03-115
Size: 160 mm

AS-03-114
BIEMER
Vein scissor
Size: 130 mm

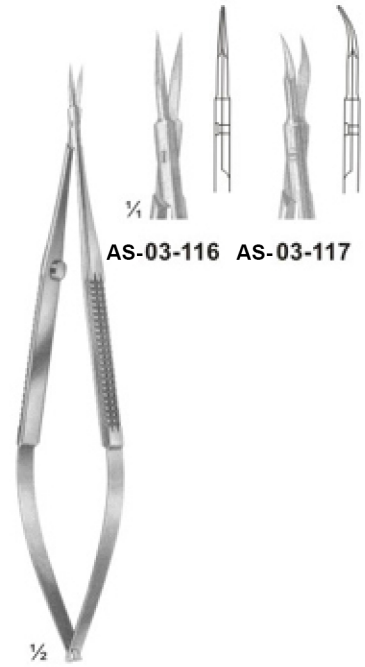

AS-03-116 AS-03-117

AS-03-116 - 117
VANNAS
Size: 160 mm

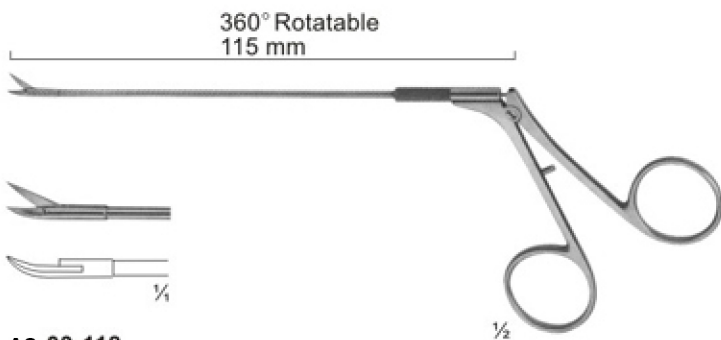

360° Rotatable
115 mm

AS-03-118
CASPAR
Micro scissor curved
Size: 115 mm

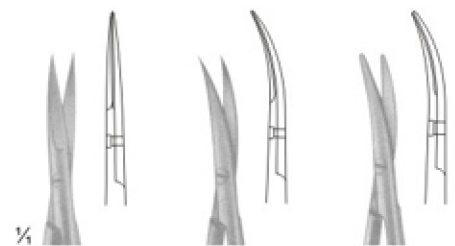

AS-03-119 AS-03-120 AS-03-121



AS-03-119 - 121
Micro dissecting scissor
Size: 145 mm

Micro Scissors (Spring Type) bayonet-Shaped



AS-03-122
YASARGIL
Size: 245 mm



AS-03-123
45°

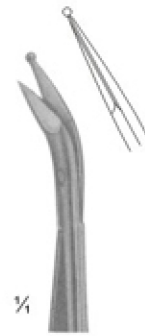

AS-03-124
45°

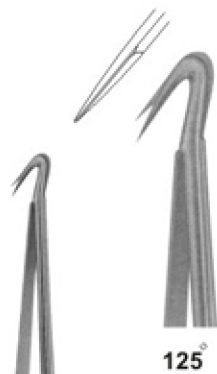

125°

AS-03-125
laterally angled
Size: 190 mm



AS-03-123 - 124
laterally angled
Size: 200 mm

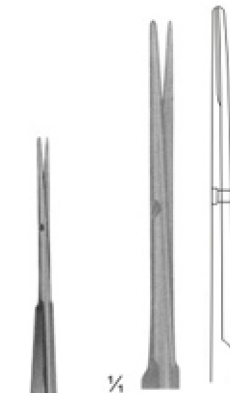

AS-03-126

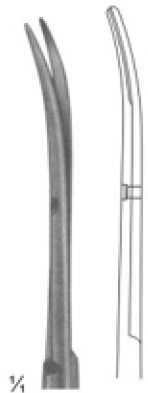

AS-03-127



AS-03-126 - 127
YASARGIL
Size: 225 mm

Delicate Scissors

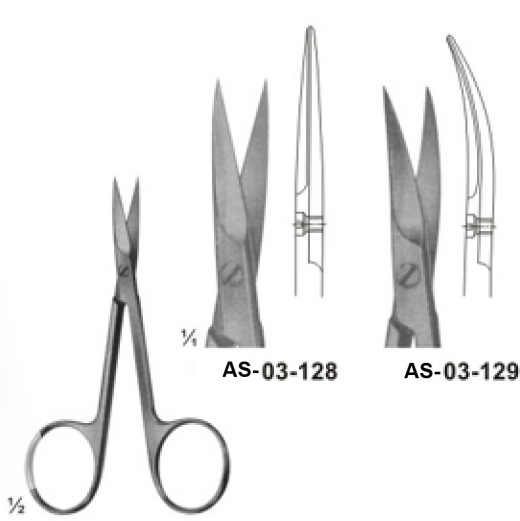

AS-03-128

AS-03-129

AS-03-128 - 129
Size: 90 mm

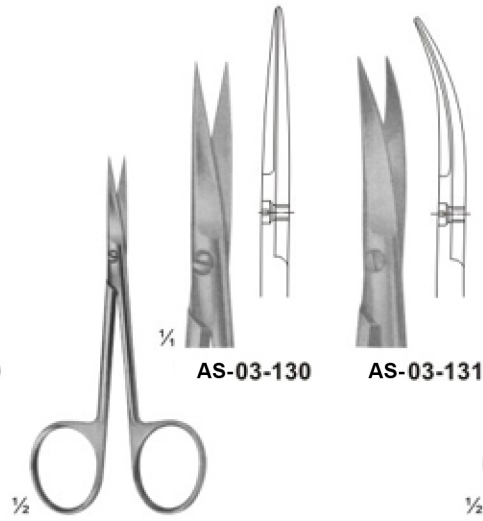

AS-03-130

AS-03-131

AS-03-130 - 131
Size: 95 mm

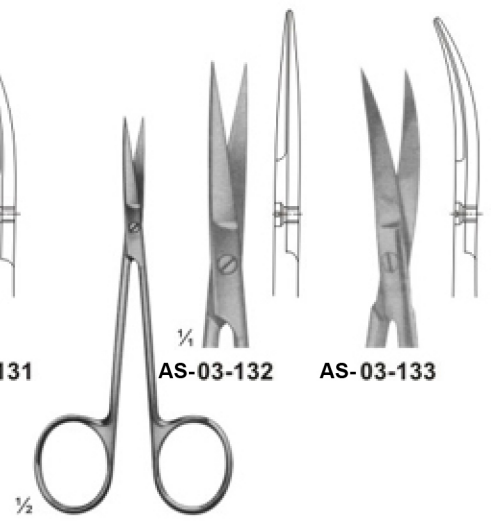

AS-03-132

AS-03-133

AS-03-132 - 133
Size: 105 mm

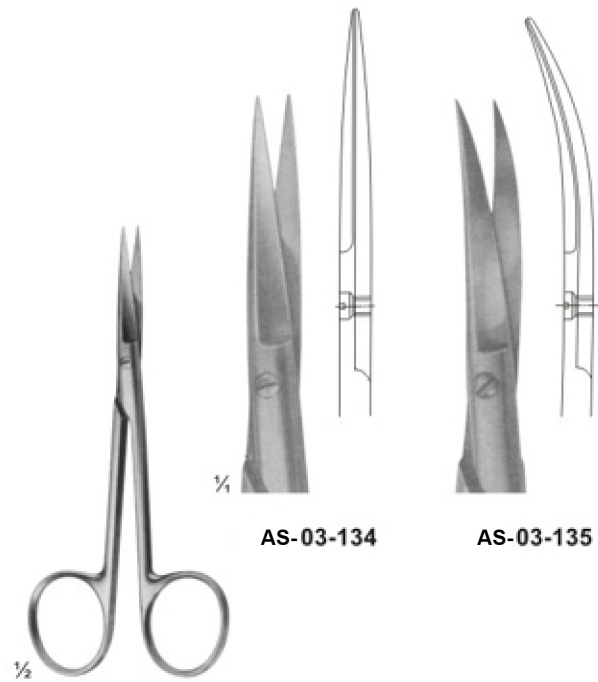

AS-03-134

AS-03-135

AS-03-134 - 135
Size: 120 mm

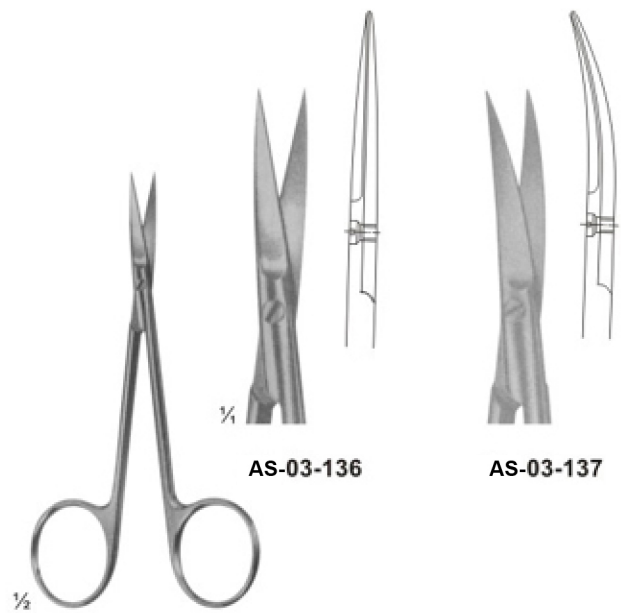

AS-03-136

AS-03-137

AS-03-136 - 137
Size: 115 mm

Delicate Scissors



1/2

AS-03-138 - 140
Size: 120 mm

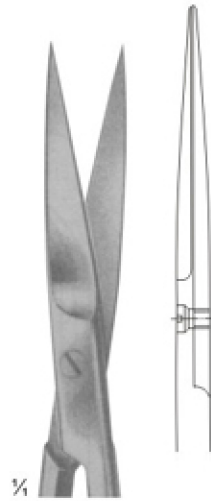

1/4

AS-03-138

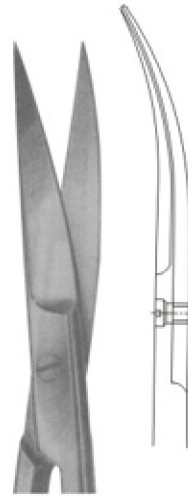

AS-03-139

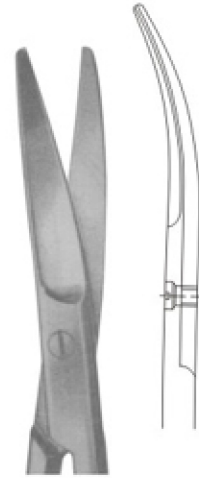

03-140



1/2

AS-03-141 - 144
Size: 130 mm

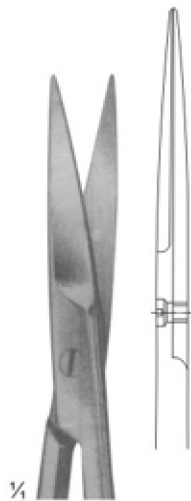

1/4

AS-03-141

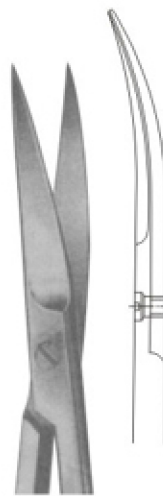

AS-03-142

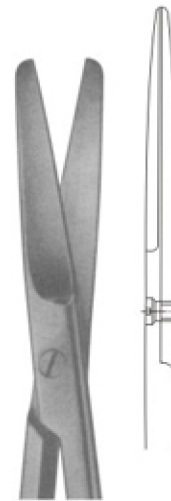

AS-03-143

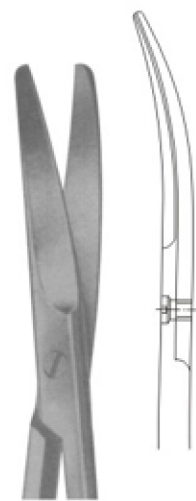

AS-03-144

Surgical Scissors

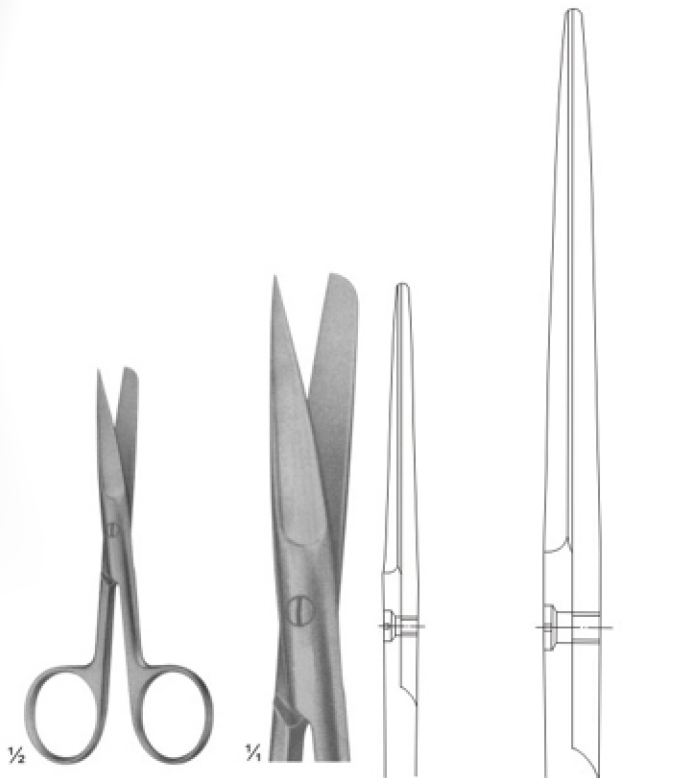

AS-03-145 - 153 (Standard types)
AS-03-145 (105 mm)
AS-03-146 (115 mm)
AS-03-147 (130 mm)
AS-03-148 (145 mm)
AS-03-149 (150 mm)
AS-03-150 (165 mm)
AS-03-151 (175 mm)
AS-03-152 (185 mm)
AS-03-153 (200 mm)

AS-03-145 Size: 105 mm
AS-03-153 Size: 200 mm



AS-03-154 - 160 (Standard types)
AS-03-154 (115 mm)
AS-03-155 (130 mm)
AS-03-156 (145 mm)
AS-03-157 (150 mm)
AS-03-158 (165 mm)
AS-03-159 (175 mm)
AS-03-160 (185 mm)

AS-03-154 Size: 115 mm
AS-03-160 Size: 185 mm

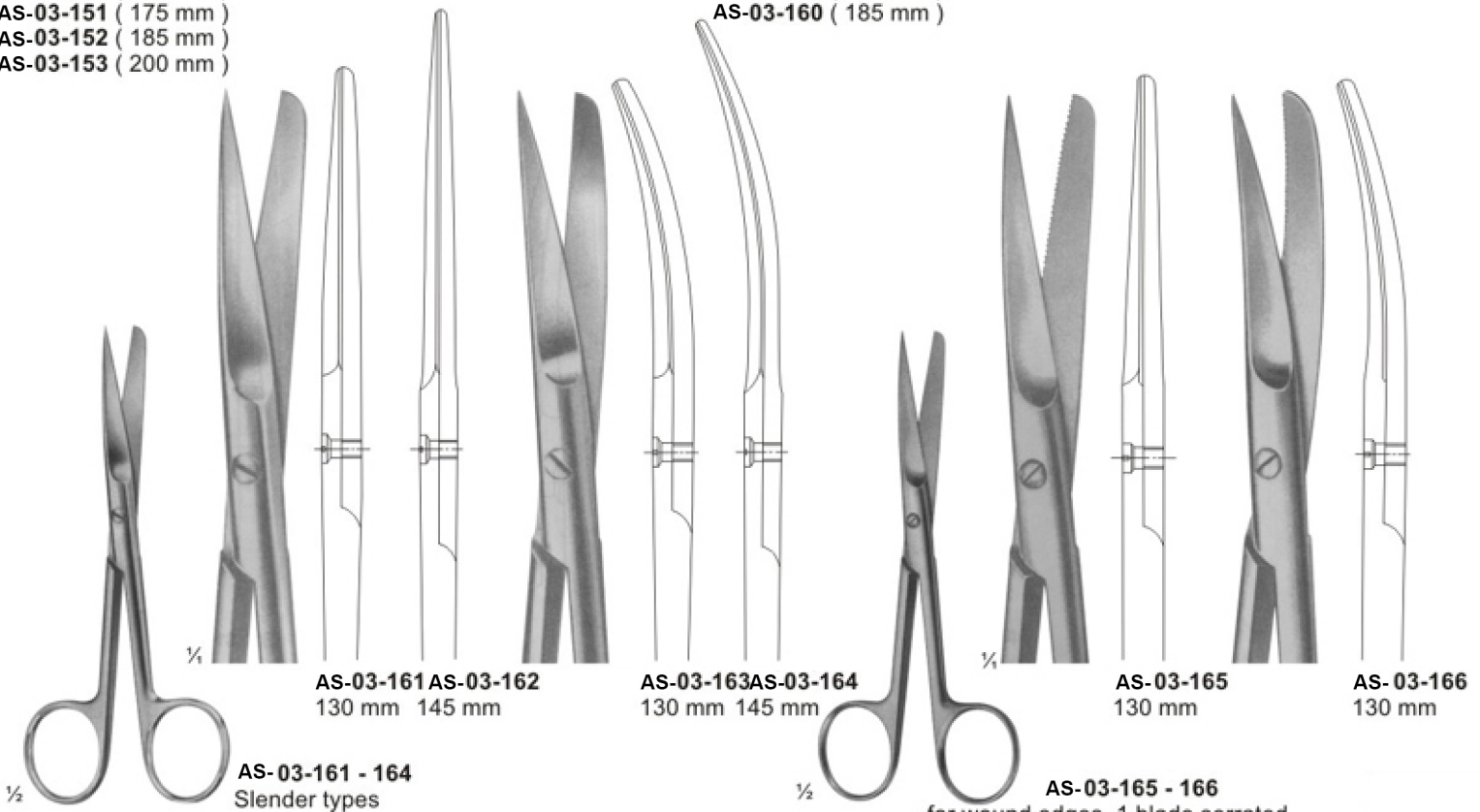

AS-03-161 - 164 Slender types
AS-03-161 130 mm
AS-03-162 145 mm
AS-03-163 130 mm
AS-03-164 145 mm

AS-03-165 - 166 for wound edges. 1 blade serrated
AS-03-165 130 mm
AS-03-166 130 mm

Surgical Scissors

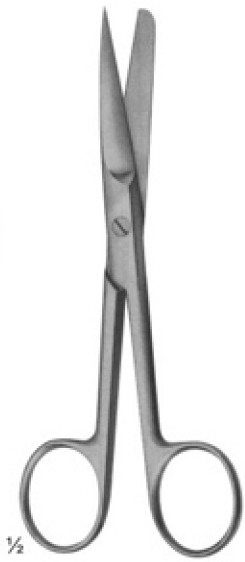

AS-03-167 - 169
DEAVER
with flat lock

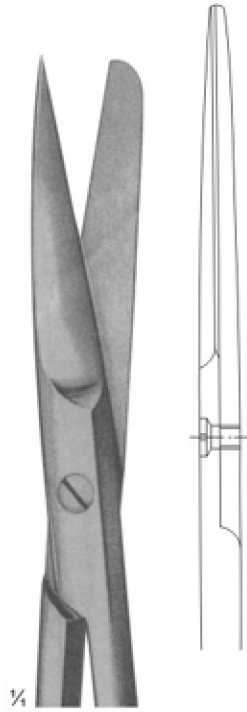

AS-03-167
Size: 145 mm

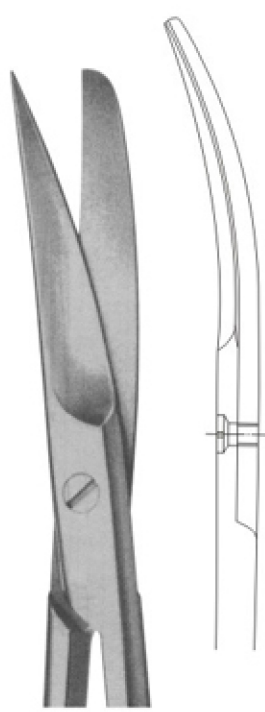

AS-03-168
Size: 145 mm

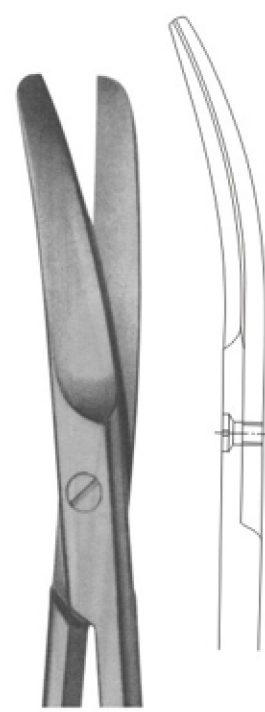

AS-03-169
Size: 145 mm



AS-03-170 - 172
Incision scissors

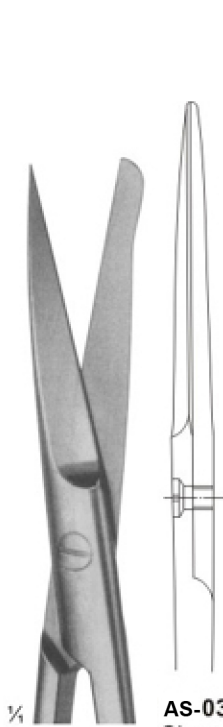

AS-03-170
Size: 130 mm



AS-03-171
Size: 145 mm

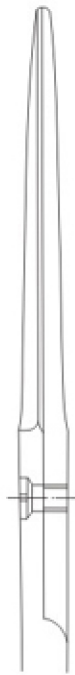

AS-03-172
Size: 165 mm

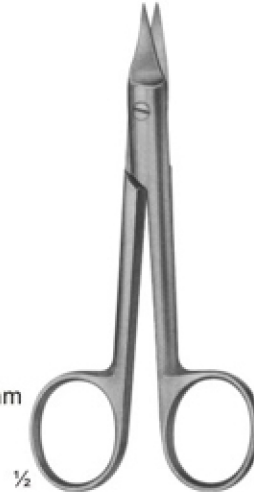

AS-03-173
SYSTRUNK
Nail splitting scissors

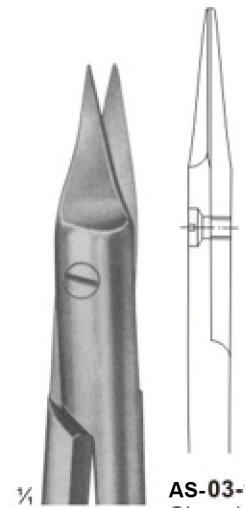

AS-03-173
Size: 130 mm

Dissecting Scissors

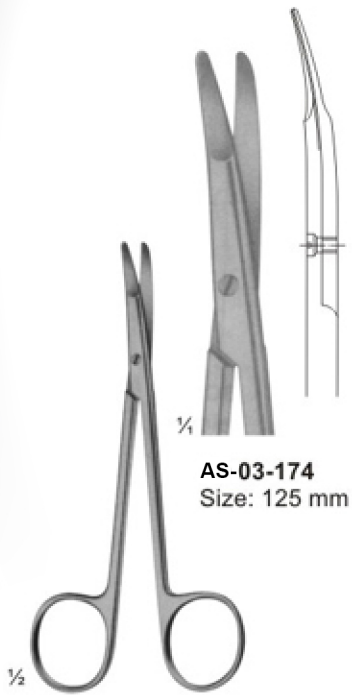

AS-03-174
Size: 125 mm

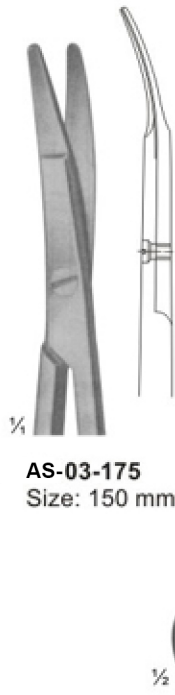

AS-03-175
Size: 150 mm

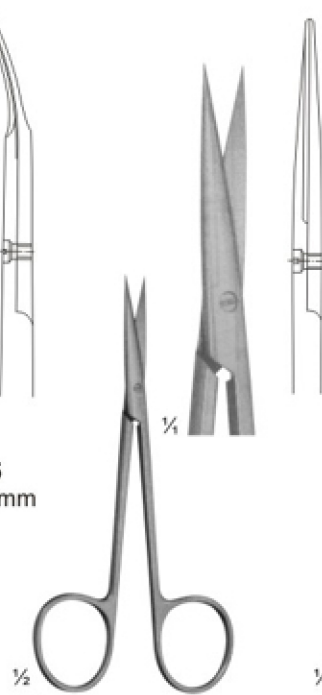

AS-03-176
KILNER
Fine dissecting scissors
Size: 115 mm

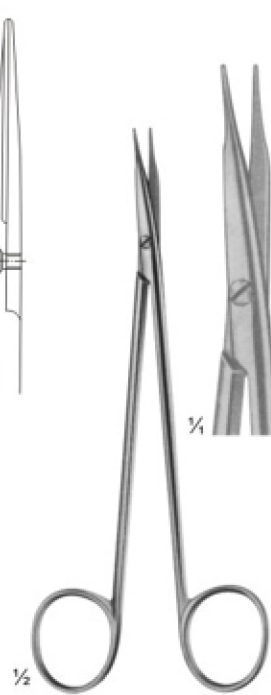

AS-03-177
JAMESON
Dissecting scissors
Size: 150 mm

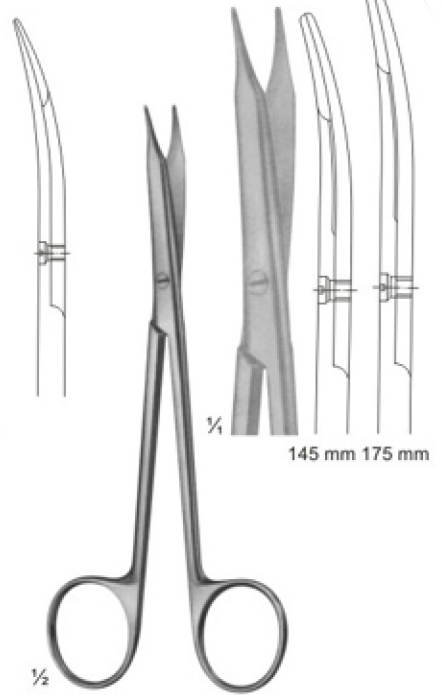

AS-03-178
REYNOLDS
Dissecting scissors
Size: 145 - 175 mm

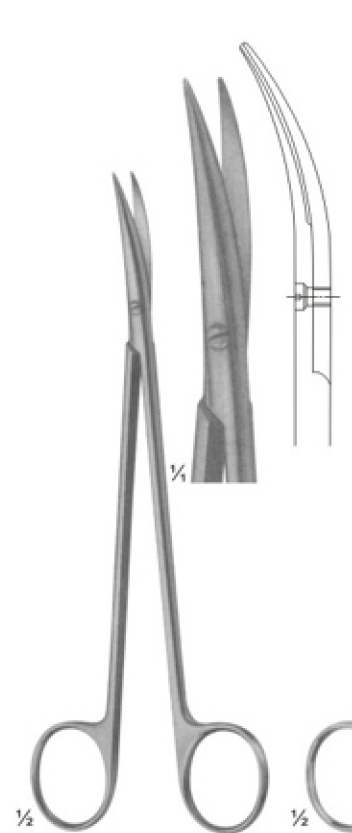

AS-03-179
DE BAKEY
Arteriotomy scissors
Size: 175 mm

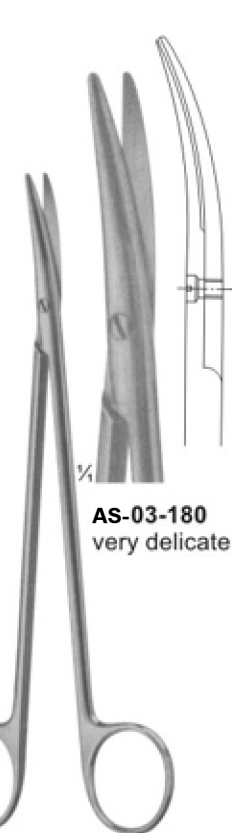

AS-03-180 - 181
TOENNIS ADSON
Dissecting scissors
Size: 175 mm

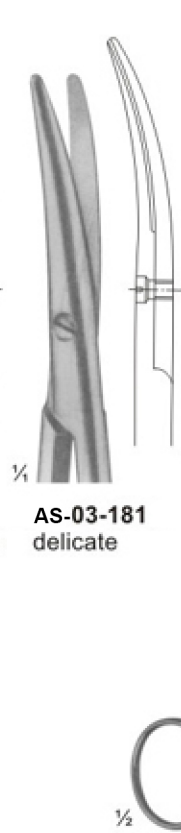

AS-03-181
delicate

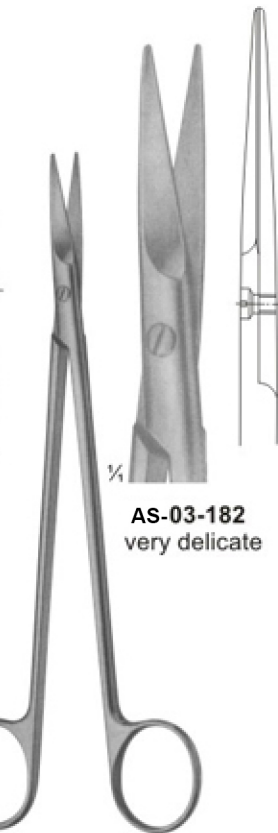

AS-03-182 - 184
TOENNIS
Dissecting scissors
Size: 180 mm



AS-03-183
delicate

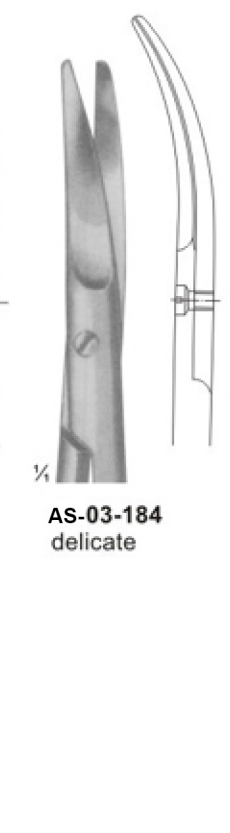

AS-03-184
delicate

Dissecting Scissors

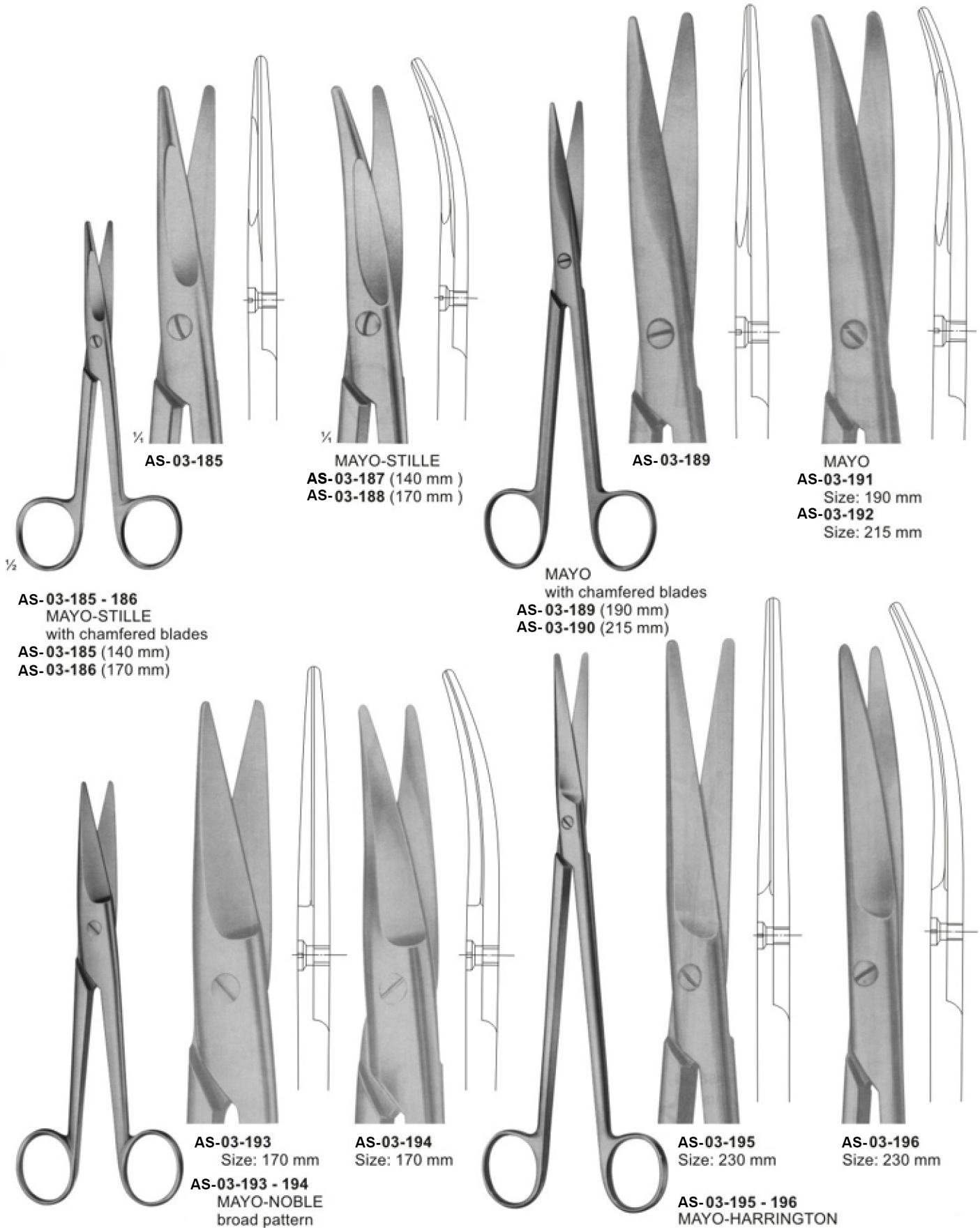

AS-03-185

MAYO-STILLE
AS-03-187 (140 mm)
AS-03-188 (170 mm)

AS-03-189

MAYO
AS-03-191
Size: 190 mm
AS-03-192
Size: 215 mm

AS-03-185 - 186
MAYO-STILLE
with chamfered blades
AS-03-185 (140 mm)
AS-03-186 (170 mm)

MAYO
with chamfered blades
AS-03-189 (190 mm)
AS-03-190 (215 mm)

AS-03-193
Size: 170 mm

AS-03-194
Size: 170 mm

AS-03-195
Size: 230 mm

AS-03-196
Size: 230 mm

AS-03-193 - 194
MAYO-NOBLE
broad pattern

AS-03-195 - 196
MAYO-HARRINGTON

Scissors for Cardiovascular and Neuro-Surgery



AS-03-197
OLIVECRONA
Dura scissors

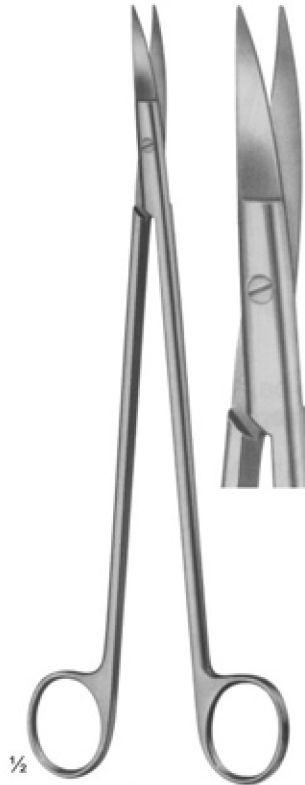

AS-03-198
STRULLY
pointed
Size: 220 mm

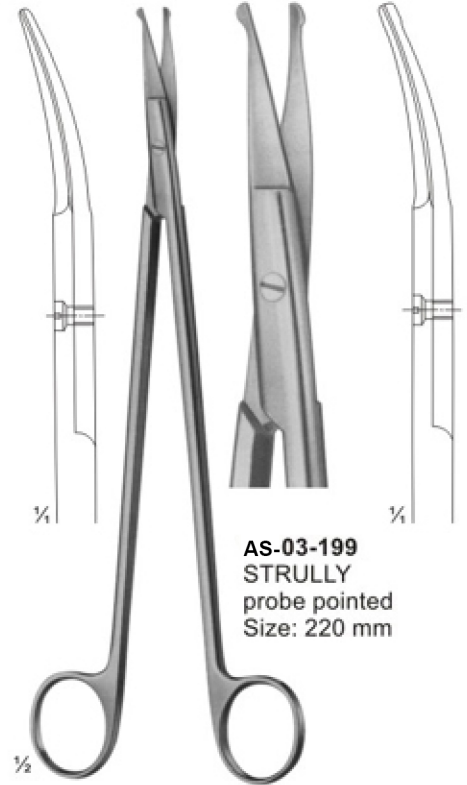

AS-03-199
STRULLY
probe pointed
Size: 220 mm

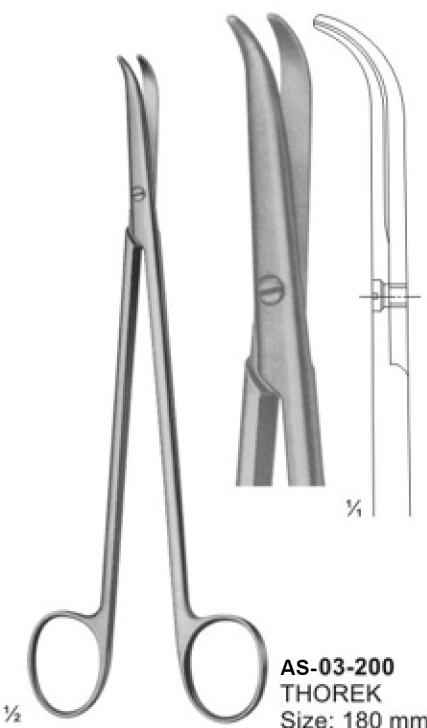

AS-03-200
THOREK
Size: 180 mm

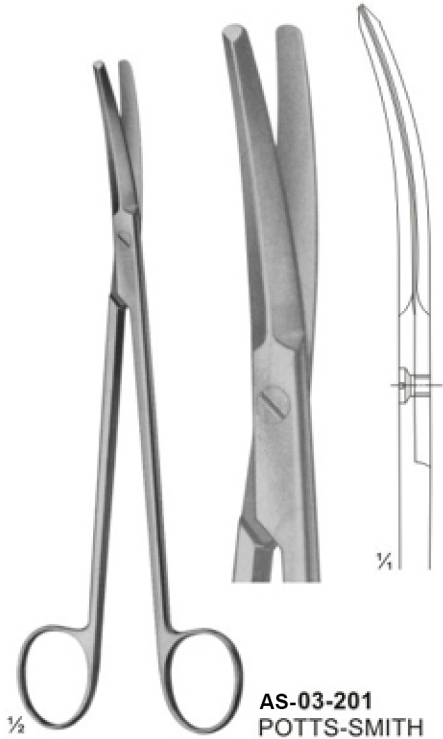

AS-03-201
POTTS-SMITH
Size: 190 mm

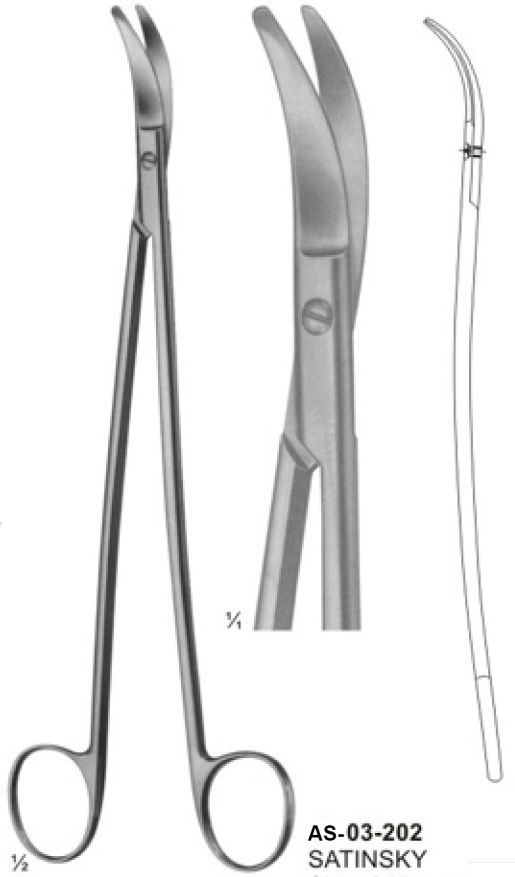

AS-03-202
SATINSKY
Size: 245 mm

Delicate, Nasal and Tonsil Scissors

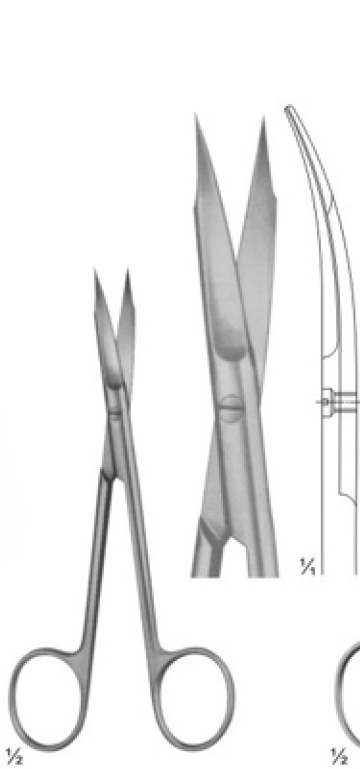

AS-03-203
1 finely toothed blade
Size: 130 mm

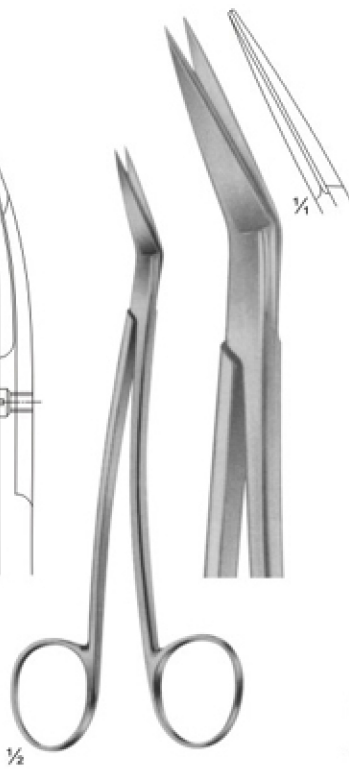

AS-03-204
LOCKLIN
curved sideways,
1 toothed blade
Size: 155 mm

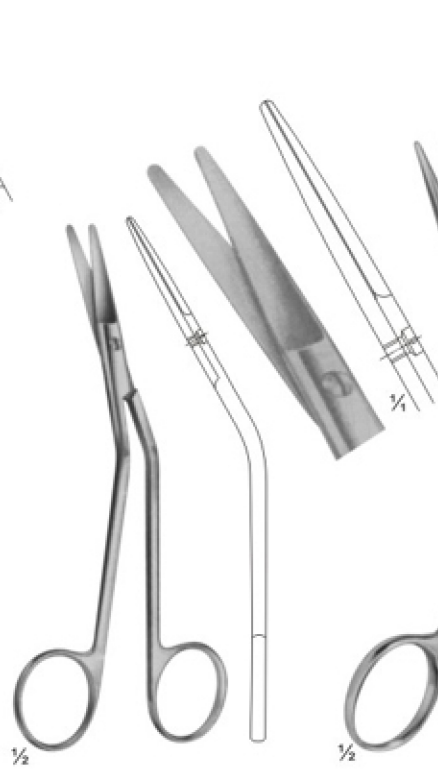

AS-03-205
FOMON
blades serrated
Size: 145 mm

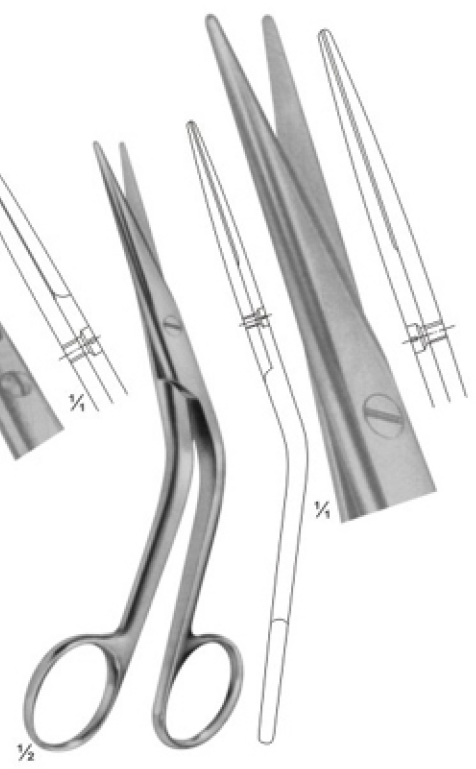

AS-03-206
COTTLE
Size: 165 mm



AS-03-207
HEYMANN-KNIGHT
Size: 175 mm

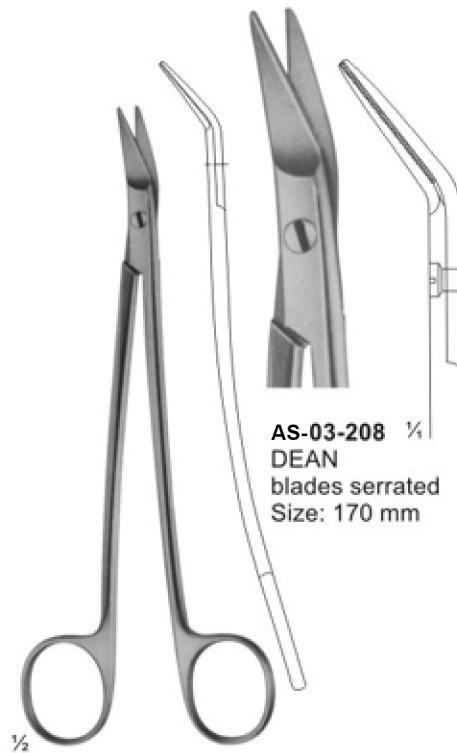

AS-03-208 1/2
DEAN
blades serrated
Size: 170 mm

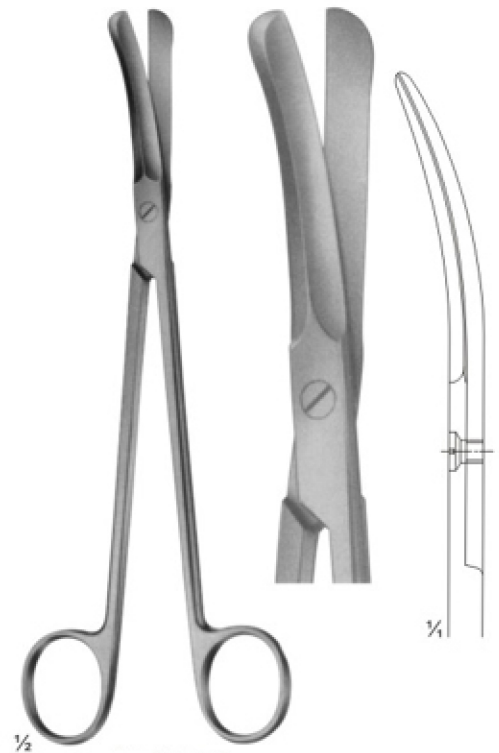

AS-03-209
GOOD
Size: 195 mm

Bone Shears



AS-03-210
KILLIAN
Size: 200 mm

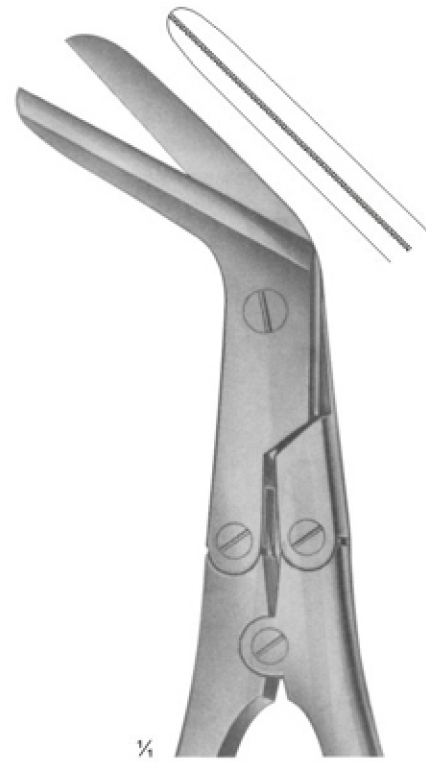

AS-03-211 - 03-212

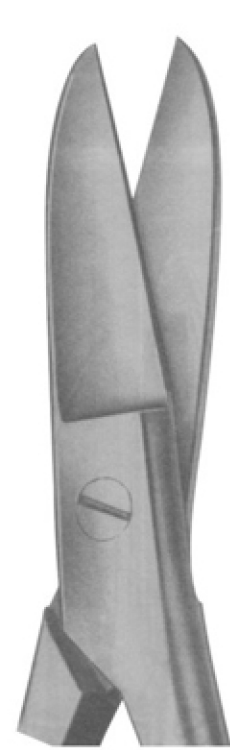

AS-03-211
195 mm



AS-03-212
225 mm

Scissors for deep operations and for Gynaecology

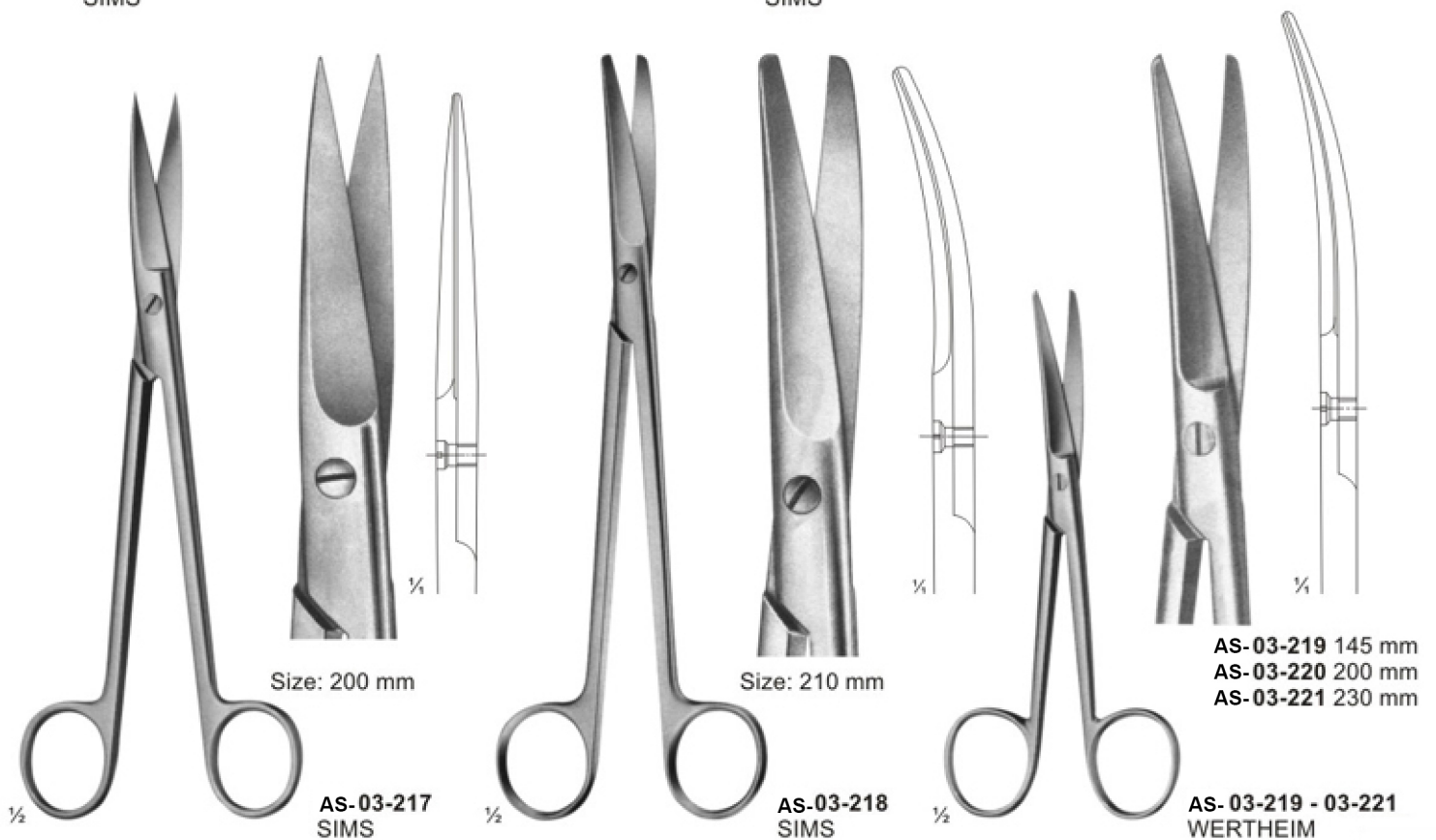
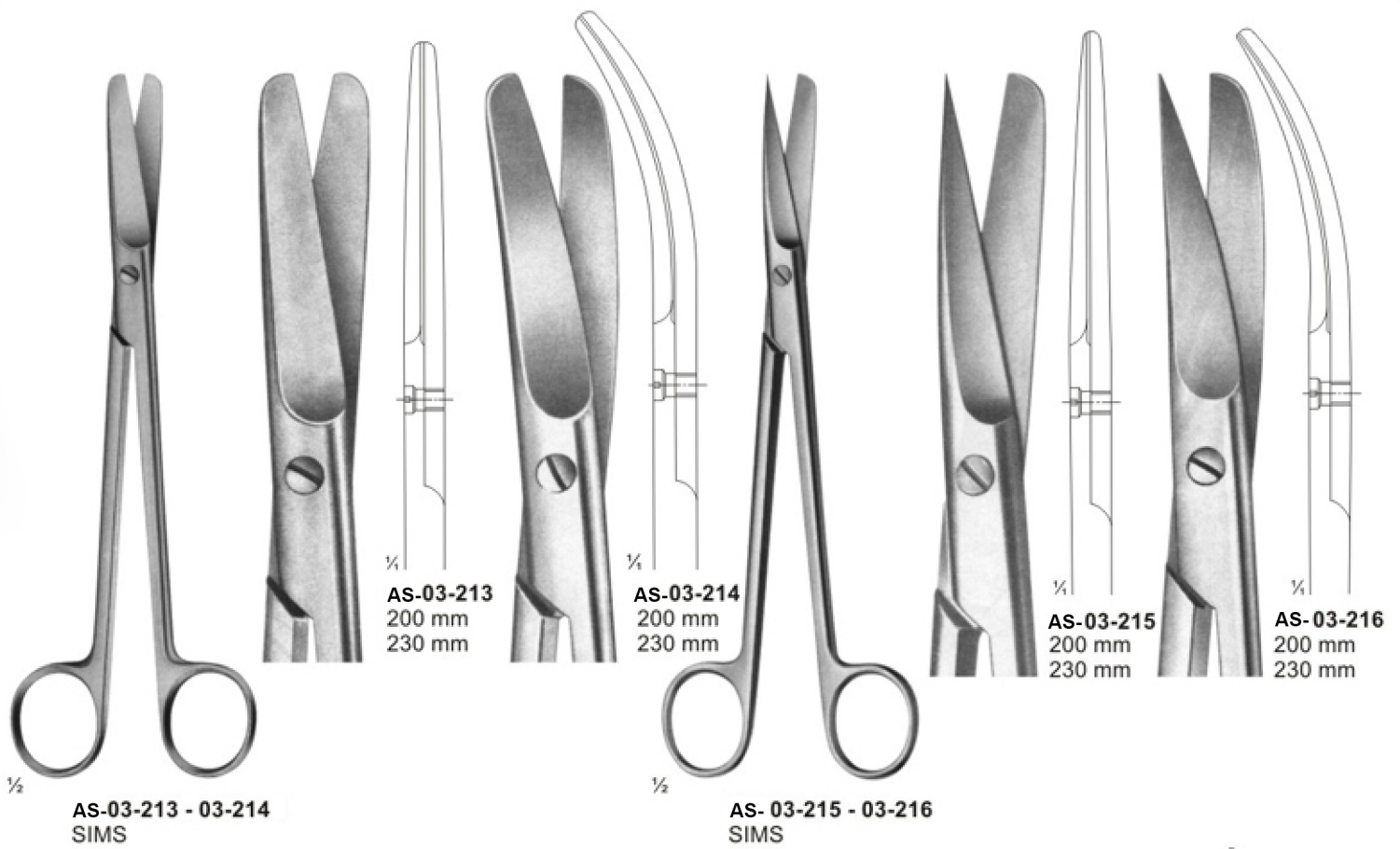

Scissors for Obstetrics



AS-03-222
SCHUMACHER
 Umbilical cord scissors
 Size: 155 mm

AS-03-223
 Umbilical cord scissors
 Size: 105 mm

AS-03-224
 Umbilical cord scissors
 135 mm

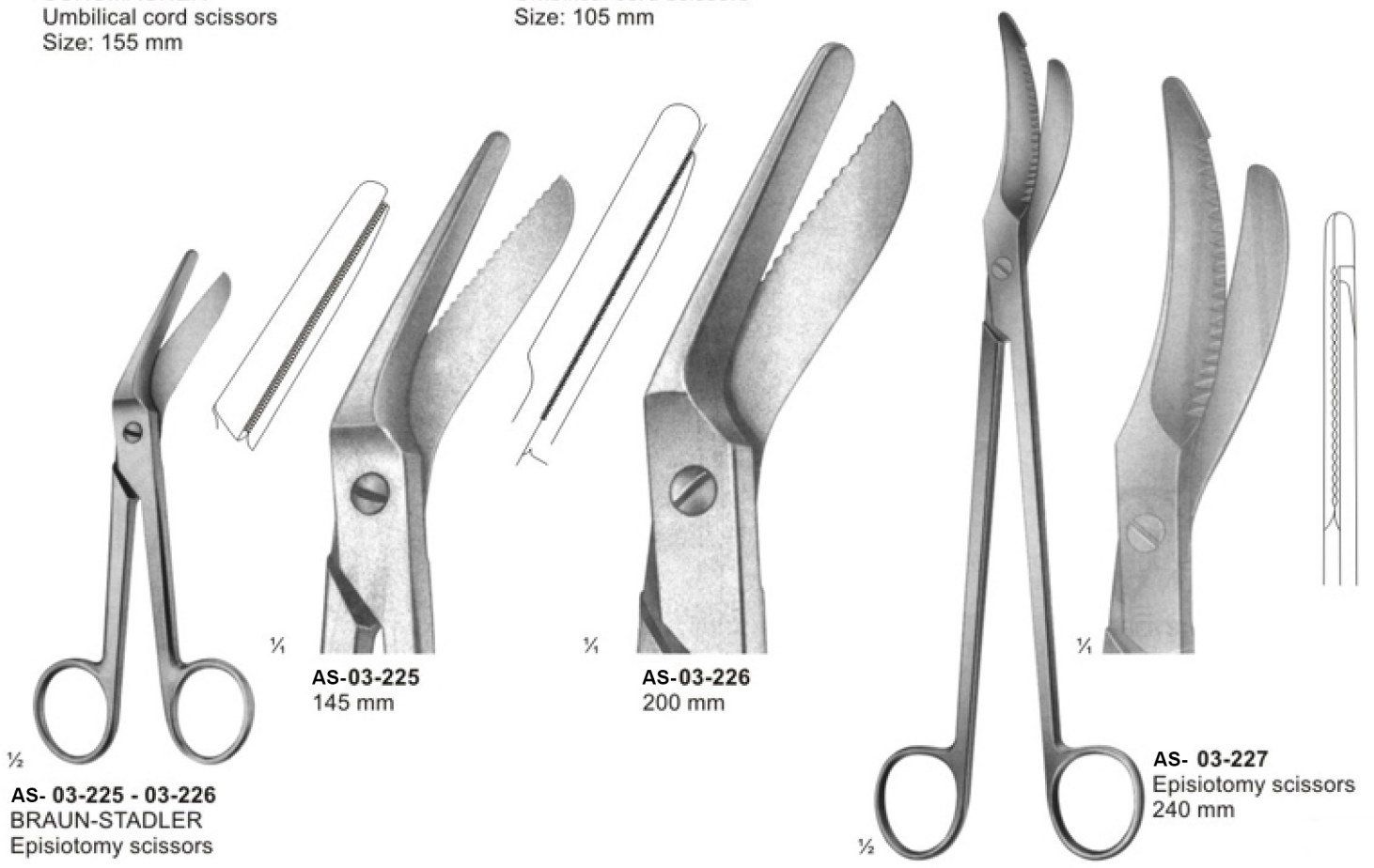

AS-03-225 - 03-226
BRAUN-STADLER
 Episiotomy scissors

AS-03-225
 145 mm

AS-03-226
 200 mm

AS-03-227
 Episiotomy scissors
 240 mm

Wire and Plate Scissors

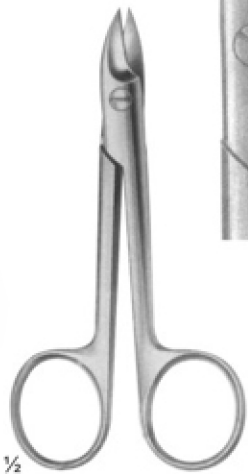

1/2

AS-03-228 - 03-232
BEEBE
Size: 110 mm

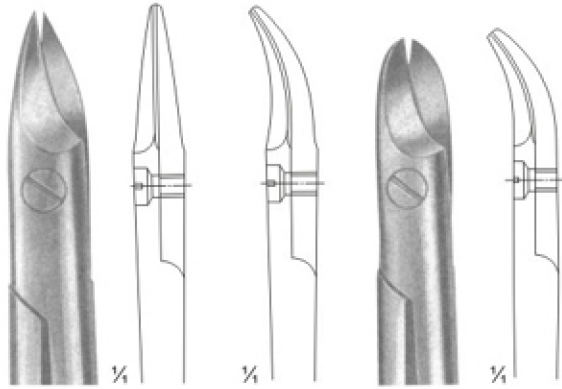

AS-03-228 AS-03-229 AS-03-230
broad blades

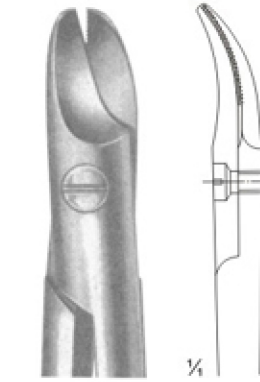

AS-03-231
1 blade serrated

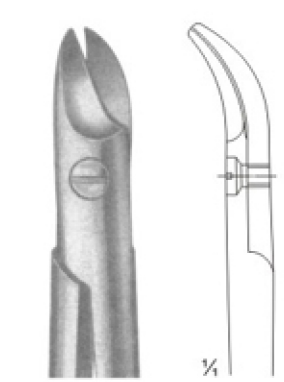

AS-03-232
NAUJOKS
strongly curved

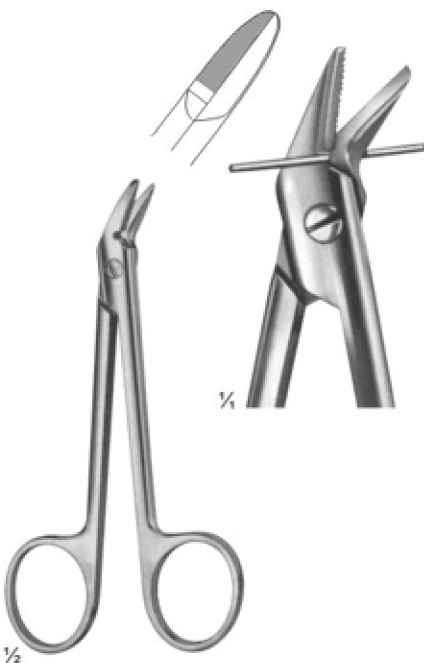

1/2

AS-03-233
1 blade serrated
Size: 120 mm

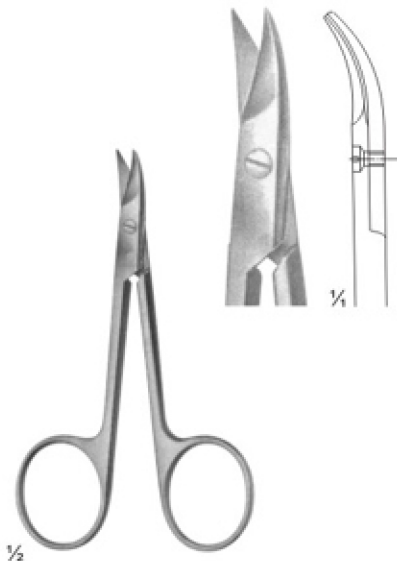

1/2

AS-03-234
STRACK
Size: 100 mm

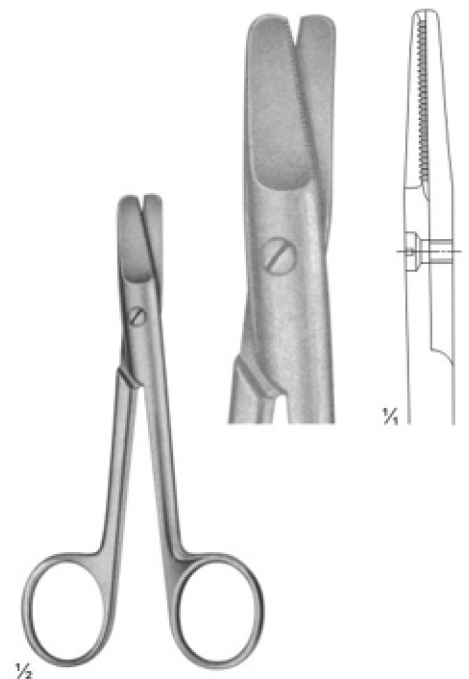

1/2

AS-03-235
HARVEY
blades serrated
Size: 125 mm

Bandage and Cloth Scissors



AS-03-236
 Universal bandage and cloth scissors,
 with toothed edges
 180 mm



AS-03-237
 LISTER
 Universal bandage and cloth scissors,
 with toothed edges
 Size: 145 mm

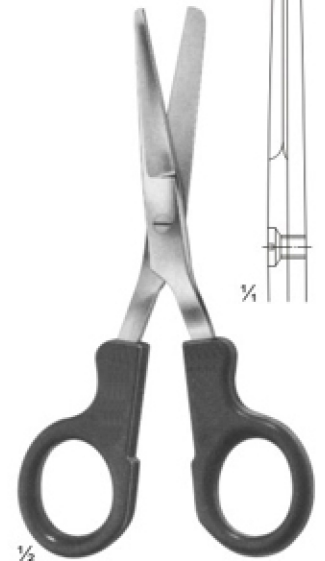

AS-03-238
 LISTER
 Nurse's scissors
 Size: 145 mm

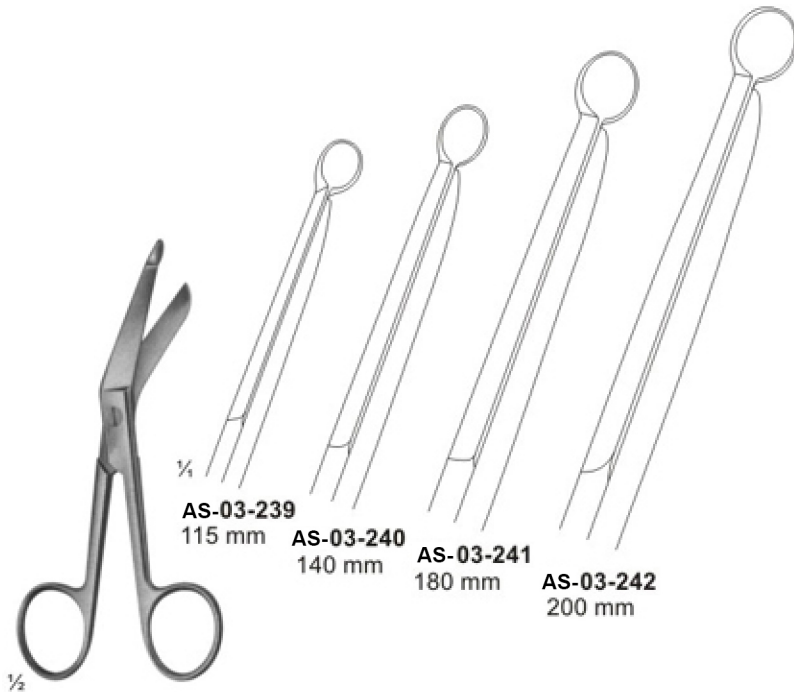

AS-03-239 - 03-242
 LISTER

- AS-03-239**
115 mm
- AS-03-240**
140 mm
- AS-03-241**
180 mm
- AS-03-242**
200 mm

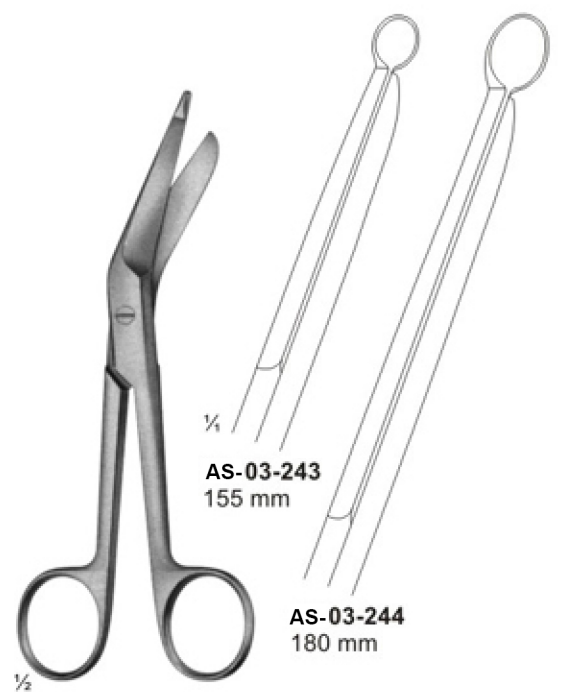

AS-03-243 - 03-244
 LISTER

- AS-03-243**
155 mm
- AS-03-244**
180 mm

Bandage-, Cloth-, and Plaster Scissors



AS-03-245
CLOTH SCISSORS
205 mm



1/2

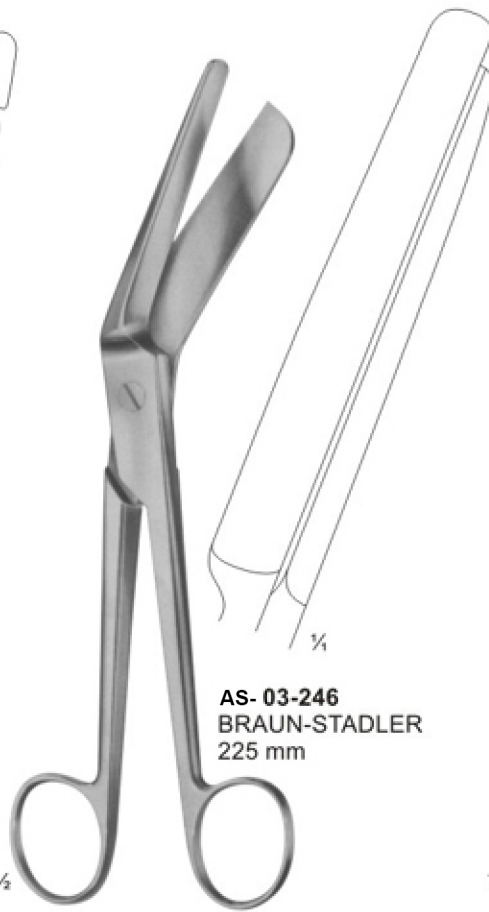

AS-03-246
BRAUN-STADLER
225 mm



1/2



AS-03-247
SEUTIN
230 mm

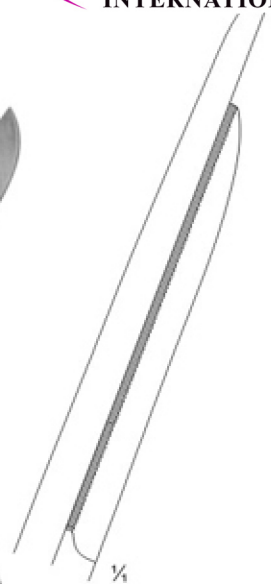

AS-03-248 **AS-03-249**
200 mm 230 mm

03-248 - 03-249
ESMARCH

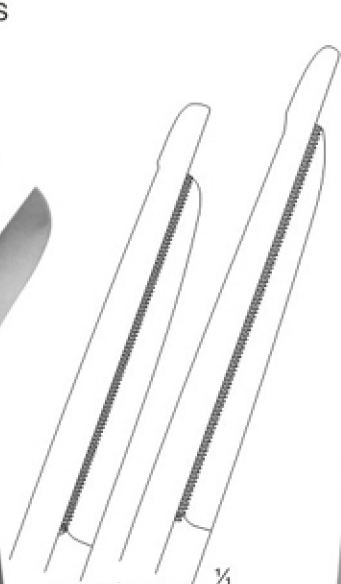

1/2

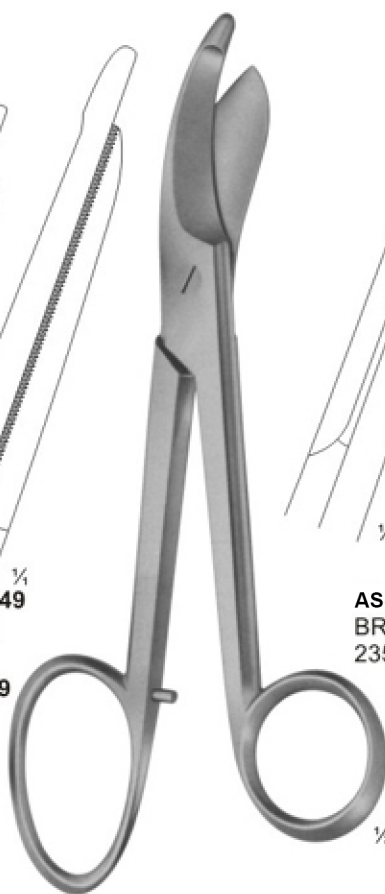

AS-03-250
BRUNS
235 mm



1/2



AS-03-251
Bandage Scissors
235 mm

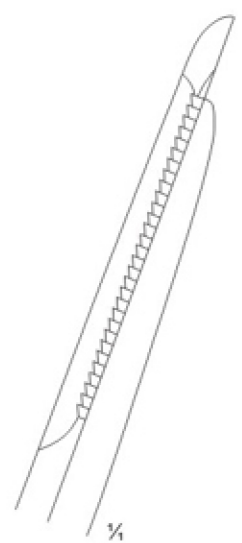

1/2



The name of Excellence

ASA INTERNATIONAL

*Near Jamia Mosque Usman,
Kotli Behram Sialkot 51310 Pakistan
Mob / Whatsapp
+92 345 6749489 (Swift Response)
Phone Number
Tel :+92 52 4267150
Fax: +92 52 4267151
Email
info@asa-intl.net
Web
http://asa-intl.net*

ASA EXPORT HOUSE

*Sultan Soap Street,
Kotli Behram Sialkot 51310 Pakistan
Mob / Whatsapp
+92 345 6749489 (Swift Response)
Phone Number
Tel :+92 52 4262983
Fax: +92 52 4267151
Email
info@asa-intl.net
Web
http://asa-intl.net*



MHRA
Regulating Medicines and Medical Devices

