

info@asa-intl.com

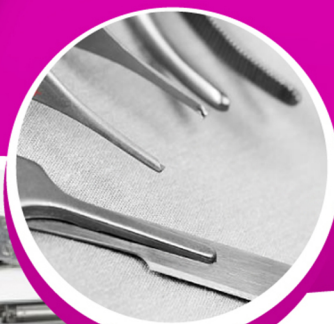

ASA

The name of Excellence

Manufacturer & Exporter All Kinds of

SURGICAL INSTRUMENTS



MHRA
Regulating Medicines and Medical Devices

Needle Holders for micro surgery



AS-05-101
ROHRSCHEIDER
with copper inserts
100 mm



AS-05-102
KALT
with catch
135 mm



AS-05-103
ARRUGA
with catch
135 mm



AS-05-104 - 105
CASTROVIEJO
with catch
145 mm



AS-05-106 - 107
without Catch
160 mm



AS-05-108 - 109
without catch
185 mm

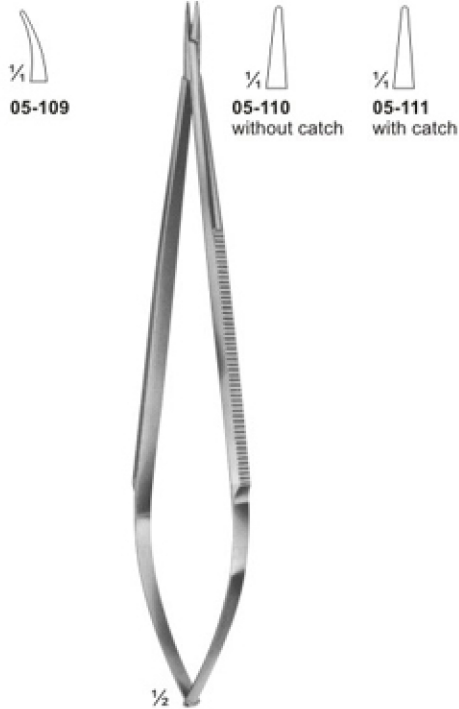

AS-05-110 - 111
JACOBSON
185 mm



AS-05-112
without catch
195 mm



AS-05-113 - 114
YASARGIL
with catch
200 mm

Needle Holders



05-115 150 mm
05-116 180 mm
05-117 200 mm

AS- 05-115 - 117
MAYO-HEGAR
medium fine patterns

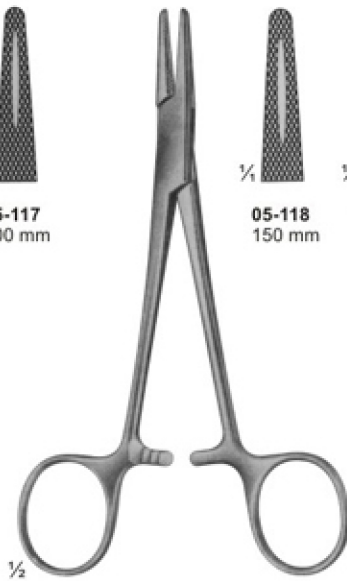

05-118 150 mm
05-119 175 mm
05-120 205 mm
05-121 205 mm

AS- 05-118 - 121
HEGAR
heavy patterns

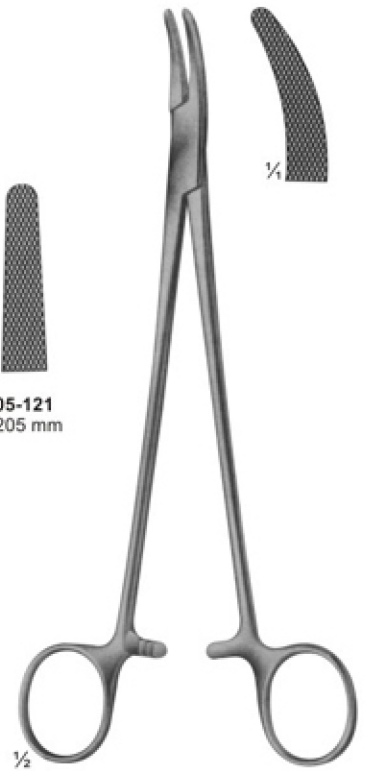

AS- 05-122
HEANEY (HEGAR)
200 mm

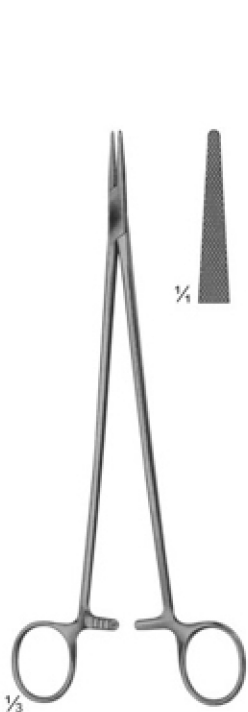

AS-05-123
JAMESON
230 mm



AS- 05-124
WANGENSTEEN
275 mm



AS-05-125
MASSON
265 mm

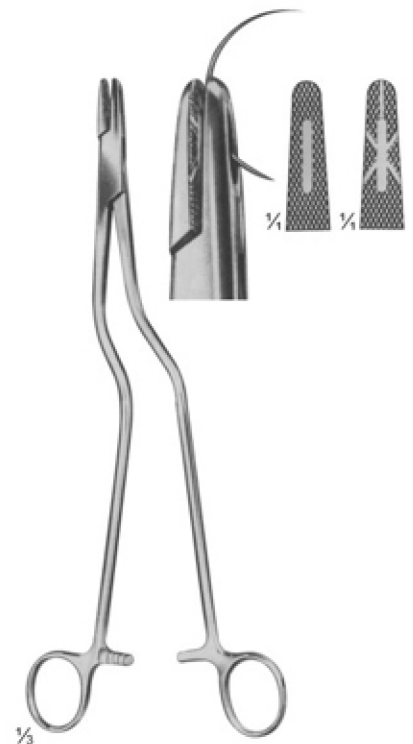

AS- 05-126
MASSON-LUETHY
255 mm

Needle Holders

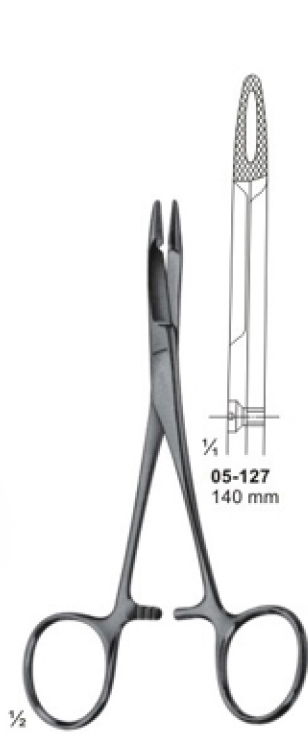

05-127
140 mm

05-127 - 128
HEGAR-OLSEN
255 mm

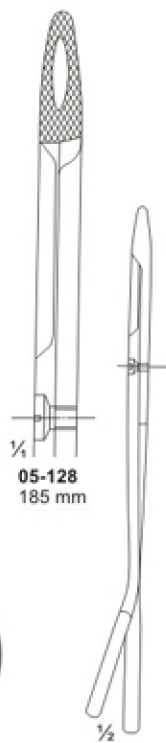

05-128
185 mm

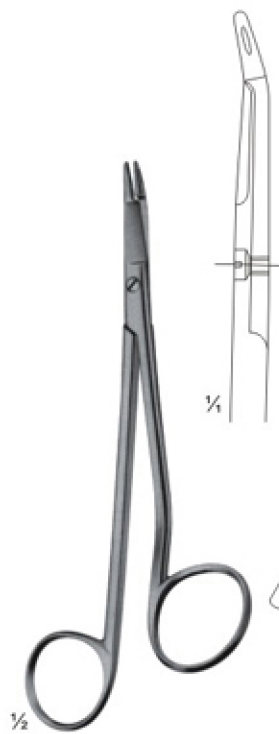

05-129
GILLIES
150 mm



05-130
GILLIES
160 mm

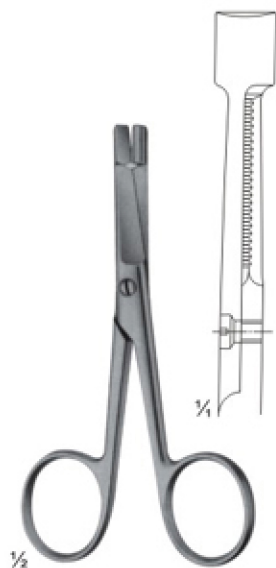

05-131
EISELSBERG
115 mm

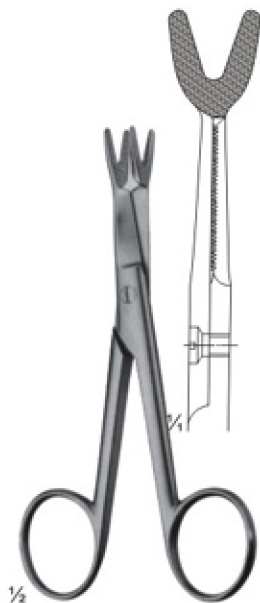

05-132
SCHOEMAKER-LOTH
125 mm



05-133
CRILE
150 mm



05-134
TOENNIS
Elastic pattern for dura-or
intestinal suture. 180 mm

Needle Holders

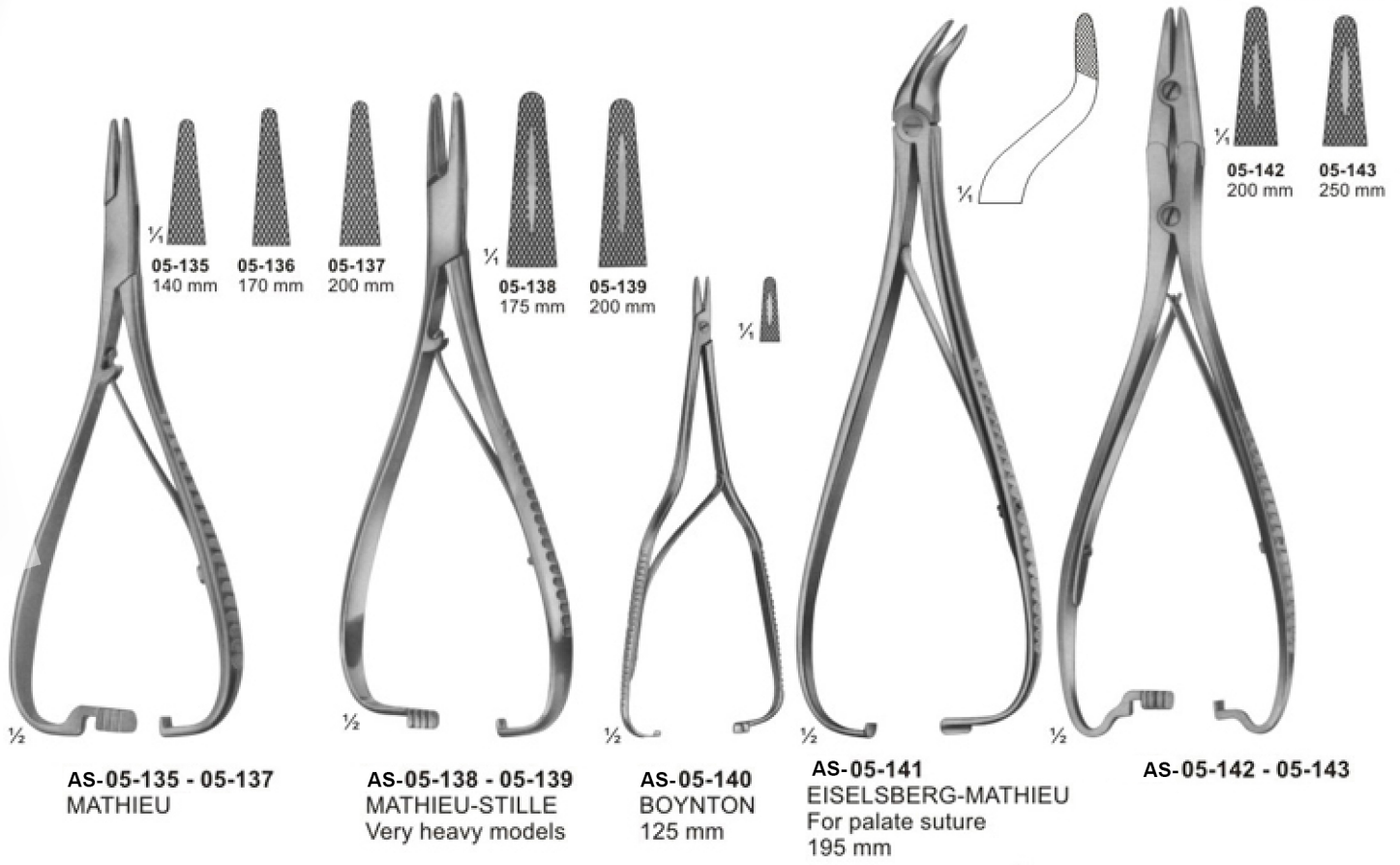

AS-05-135 - 05-137
MATHIEU

AS-05-138 - 05-139
MATHIEU-STILLE
Very heavy models

AS-05-140
BOYNTON
125 mm

AS-05-141
EISELSBERG-MATHIEU
For palate suture
195 mm

AS-05-142 - 05-143

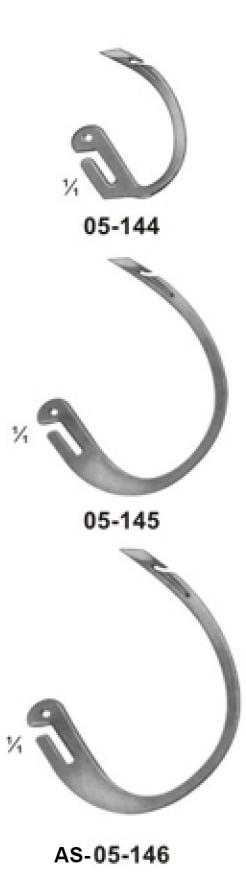

05-144

05-145

AS-05-146



AS-05-147
YOUNG-HRYNTSCHAK
With 1 needle
240 mm

AS-05-148
YOUNG-MILLIN
With 1 needle
200 mm



AS-05-149
MILLIN
Ligature holding
forceps. 245 mm

Suture Instruments - Reverdin Needles

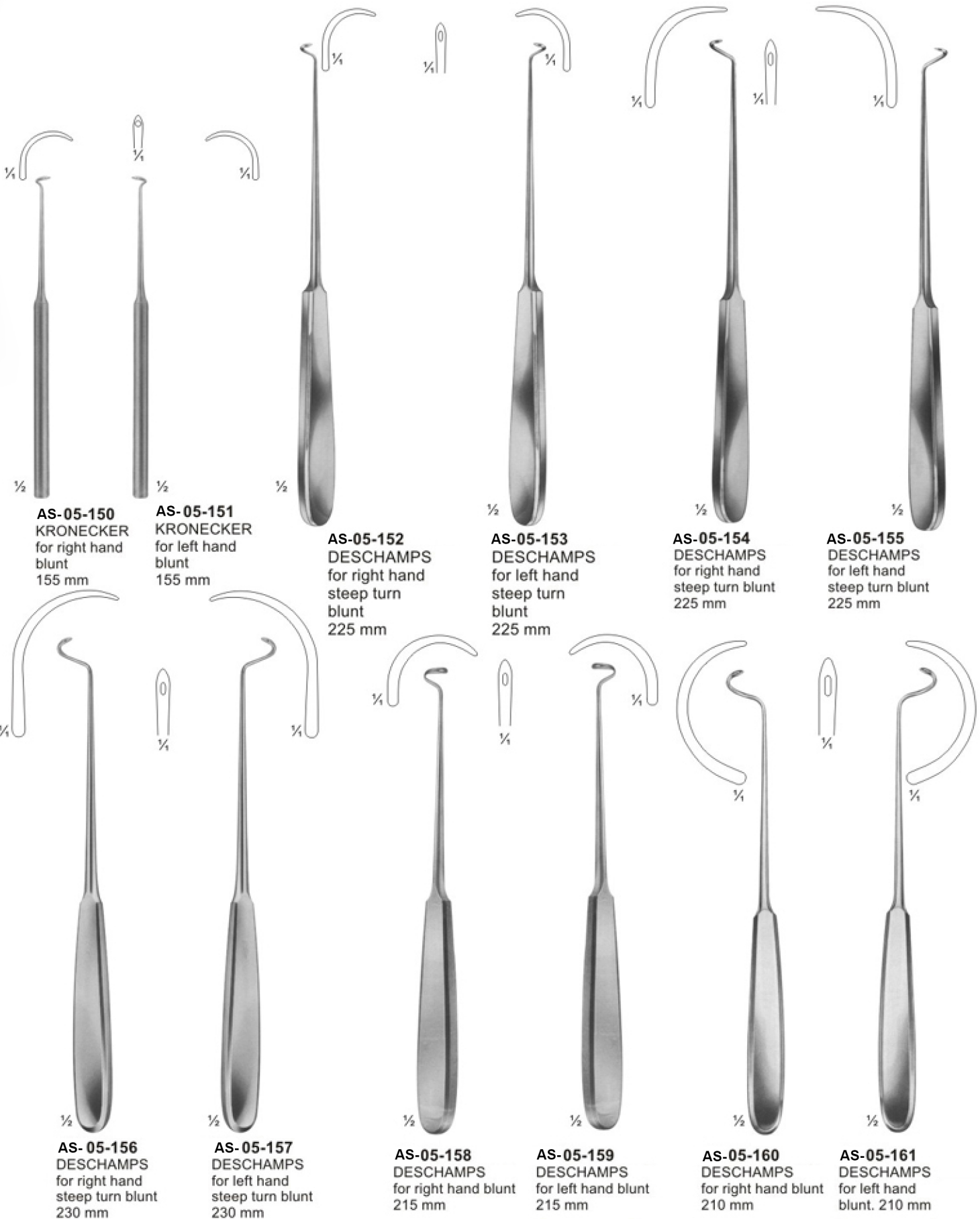

AS-05-150
KRONECKER
for right hand
blunt
155 mm

AS-05-151
KRONECKER
for left hand
blunt
155 mm

AS-05-152
DESCHAMPS
for right hand
steep turn
blunt
225 mm

AS-05-153
DESCHAMPS
for left hand
steep turn
blunt
225 mm

AS-05-154
DESCHAMPS
for right hand
steep turn blunt
225 mm

AS-05-155
DESCHAMPS
for left hand
steep turn blunt
225 mm

AS-05-156
DESCHAMPS
for right hand
steep turn blunt
230 mm

AS-05-157
DESCHAMPS
for left hand
steep turn blunt
230 mm

AS-05-158
DESCHAMPS
for right hand blunt
215 mm

AS-05-159
DESCHAMPS
for left hand blunt
215 mm

AS-05-160
DESCHAMPS
for right hand blunt
210 mm

AS-05-161
DESCHAMPS
for left hand
blunt. 210 mm



The name of Excellence

ASA INTERNATIONAL

*Near Jamia Mosque Usman,
Kotli Behram Sialkot 51310 Pakistan
Mob / Whatsapp
+92 345 6749489 (Swift Response)
Phone Number
Tel :+92 52 4267150
Fax: +92 52 4267151
Email
info@asa-intl.net
Web
http://asa-intl.net*

ASA EXPORT HOUSE

*Sultan Soap Street,
Kotli Behram Sialkot 51310 Pakistan
Mob / Whatsapp
+92 345 6749489 (Swift Response)
Phone Number
Tel :+92 52 4262983
Fax: +92 52 4267151
Email
info@asa-intl.net
Web
http://asa-intl.net*



MHRA
Regulating Medicines and Medical Devices

